

## Tranzistory nf do 1.5W

objednávací název		Uce	Ic	P	B	f	Uces	pouzdro
NPN	PNP	V	A	W		MHz	V	
■ BC547B	■ BC557B	45	0.1	0.5	200~450	100	0.6	TO92 (1)
■ BC547C	■ BC557C	45	0.1	0.5	420~800	100	0.6	TO92 (1)
■ BC546B	■ BC556B	65	0.1	0.5	200~450	100	0.6	TO92 (1)
■ BC550C		45	0.1	0.5	420~800	300	0.6	TO92 (1)
■ 2N3904	■ 2N3906	40	0.2	0.625***	30~300	>250	0.3~0.4	TO92 (2)
■ PN2222A		40	0.6	0.625	35~300	300	1	TO92 (2)
■ PN2907A		60	0.6	0.625	> 50	200	0.4**	TO92 (2)
■ BC337-25	■ BC327-25	45	0.8	0.6	160~400	100	0.7	TO92 (1)
■ BC337-40	■ BC327-40	45	0.8	0.6	250~600	100	0.7	TO92 (1)
■ BC639	■ BC640	80	1	0.8	40~160	100	0.5	TO92 (3)
■ BC107B		45	0.2	0.3	200~450	150	0.25	TO18
	■ 2N2907A	60	0.6	0.4	50~300	200	0.4	TO18
■ 2N2222A		40	0.8	0.5	100~300	300	1	TO18
■ 2N1711		50		0.8	35~300	70	0.5*	TO39
	■ 2N2905A	60	0.6	0.6	50~300	200	0.4	TO39
■ 2N2219A		40	0.8	0.8	50~300	300	0.3	TO39
■ BC141-16		60	1	0.8	100~250	50	1	TO39
■ 2N3019		80	1	0.8	15~300	100	0.2	TO39

\* šířka pulzu <= 300us, pracovní cyklus <= 2%

\*\* šířka pulzu <= 300us, pracovní cyklus <= 1%

\*\*\* montáž pájecích vývodů na měděnou desku o ploše 3mm<sup>2</sup>

### TO92 / SC43 / SOT54

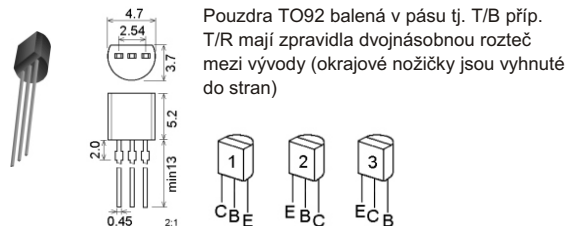

### TO18

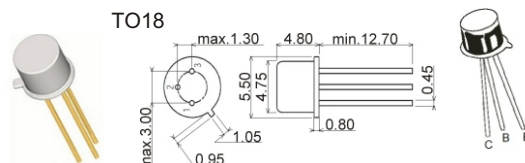

### TO39

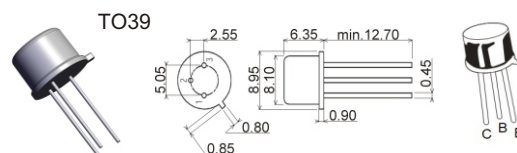

## Tranzistory nf 1.5W a více

objednávací název		Uce	Ic	P	B	f	Uces	pouzdro
NPN	PNP	V	A	W		MHz	V	
■ BD135-16	■ BD136-16	45	1.5	12.5	100~250	50	0.5	TO126
■ BD137-16	■ BD138-16	60	1.5	8	100~250	50	0.5	TO126
■ BD139-10	■ BD140-10	80	1.5	8	60~160	50	0.5	TO126
■ BD139-16	■ BD140-16	80	1.5	8	100~250	50	0.5	TO126
■ BD139	■ BD140	80	1.5	8	25~250	50	0.5	TO126
■ BD237	■ BD238	80	2	25	40~250	3	0.6	TO126
■ BD437		45	4	36	> 30	3	0.6	TO126
■ BD439		60	4	36	> 20	3	0.8	TO126
■ BD441	■ BD442	80	4	36	40~140	3	0.8	TO126
■ 2SC4793	■ 2SA1837	230	1	2	100~320	> 70	1.5	TO220IS
■ BD243C	■ BD244C	100	6	65	> 15	3	1.5	TO220
■ BU406		200	7	60		10	1	TO220
■ MJE15032	■ MJE15033	250	8	50	> 10	30	0.5	TO220
■ D44H11		60	10	50	40~60		1	TO220
■ D44H8		60	10	50	40~60		1	TO220
■ MJE3055T	■ MJE2955T	60	10	75	5~70	2	1.1	TO220
	■ BD712	100	12	75	> 15	3	1	TO220
■ BUV27G		120	12	70			0.7	TO220
■ 2N6488	■ 2N6491	80	15	75	5~150	5	3.5	TO220
■ BD911	■ BD912	100	15	90	> 5	3	3	TO220
■ TIP3055	■ TIP2955	60	15	90	> 5		3	TO247

### TO126 / TO225AA / SOT32

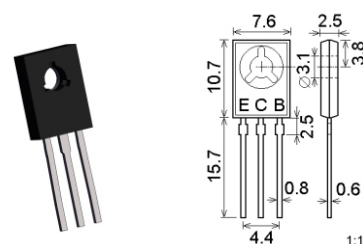

### TO220

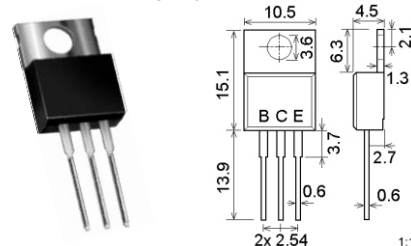

## Tranzistory nf vysokonapět'ové

objednávací název		Uce	Ic	P	B	f	Uces	pouzdro
NPN	PNP	V	A	W		MHz	V	
	■ 2N5551	160	0.6	0.63*	30~250	300	0.2	TO92 (2)
	■ MPSA92 T/R	300	0.5	0.63	> 25	50	0.5	TO92 (2)
■ MPSA42		300	0.5	0.63*	> 25	> 50	0.5	TO92 (2)
■ MJE340	■ MJE350	300	0.5	20	30~240			TO126

\* pokud při okolní teplotě jsou vodiče ve vzdálenosti 2mm od pouzdra

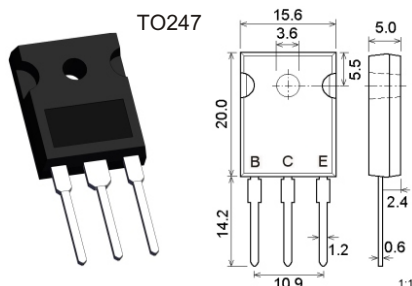

### TO220IS

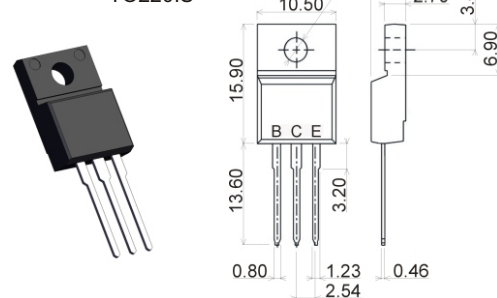

TO220IS - chladičský plech oddělen od vnějšího prostředí zalitím v plastovém izolantu (tl. zalitého plechu cca + 1mm)

## Tranzistory výkonové spínací

objednáací název		Uce	Ic	P	Uces	R zátěž	L zátěž	pouzdro
NPN	PNP	V	A	W	V	ton / ts / tf us	ton / ts / tf us	
■ BUX85G		450	2	50	1			TO220
■ BUL38D*		450	5	80	1.1	- / 2.2 / 0.8	- / 1.8 / 100	TO220
■ BUL381D*		400	5	70	1.1	- / 2.5 / 0.8	- / 1.3 / 100	TO220
■ MJE13007		400	8	80	3	- / 3 / 0.7	- / - / 0.12	TO220
■ BUV48A		450	15	125	5	1 / 3 / 0.8	- / 5 / 0.4	TO247

\* s anti-parallelní diodou

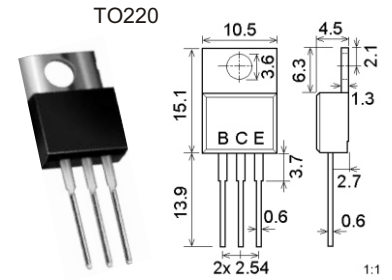

## Tranzistory Darlington

objednáací název		Uce	Ic	P	B	f	Uces	pouzdro
NPN	PNP	V	A	W		MHz	V	
■ BC517		30	0.5	0.63	> 30 000	200	1	TO92 (1)
	■ BC516	30	1	0.5	> 30 000	125	1	TO92 (1)
■ BD675A	■ BD676	45	4	40	> 750		2.5	TO126
■ BD677	■ BD678	60	4	40	> 750		2.5	TO126
■ BD679	■ BD680	80	4	40	> 750		2.5	TO126
■ BD679A	■ BD680A	80	4	40	> 750	10	2.8	TO126
■ BD681	■ BD682	100	4	40	> 750		2.5	TO126
■ TIP110		60	2	2	> 500		2.5	TO220
■ TIP120	■ TIP125	60	5	2	> 1000		4	TO220
■ TIP122	■ TIP127	100	5	2	> 1000		4	TO220
■ BD533C		100	8	60	> 750		2	TO220
■ TIP132	■ TIP137	100	8	2	500/15 000		4	TO220
■ BD533C	■ BD534C	100	10	70	> 750		2.5	TO220
■ BDW93C	# BDW94C	100	12	80	> 750		3	TO220
■ BDW93CFP	■ BDW94CFP	100	12	33	> 750		3	TO220IS
	■ TIP147	100	10	125	> 500		3	TO247
■ BDV65B	■ BDV64B	100	10	125	> 1000		2	TO247
■ MJH11017G	■ MJH11019G	150	15	150	100/15 000	3	4	TO247
■ MJH11020G	■ MJH11021G	200	15	150	100/15 000	3	4	TO247
■ MJH11022G	■ MJH11023G	250	15	150	100/15 000	3	4	TO247
■ MJH6284G	■ MJH6287G	100	20	160	100/18 000	4	3	TO247

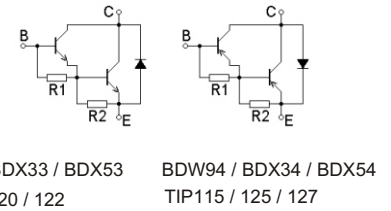

BDW93 / BDX33 / BDX53  
TIP110 / 120 / 122

BDW94 / BDX34 / BDX54  
TIP115 / 125 / 127

## Tranzistory výkonové s anti-parallelní diodou

objednáací název		Uce	Ic	P	B	f	Uces	pouzdro
NPN	PNP	V	A	W		MHz	V	
■ BUL381D		400	5	70	> 8		1:1	TO220
■ BUL38D		450	5	80	10-60		1.1	TO220

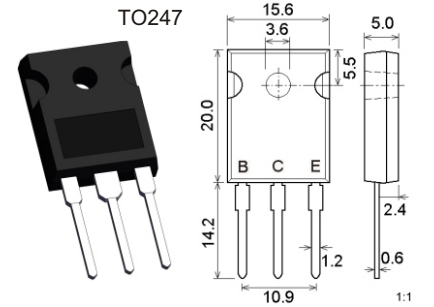

## Tranzistory vf nad 1GHz

objednáací název		Uce	Ic	P	G	f	pouzdro
NPN	PNP	V	mA	W	dB	GHz	
■ BFR91A		12	50	0.3	14	5	TO50
■ BFR96TS		15	100	0.7	11.5	5	TO50

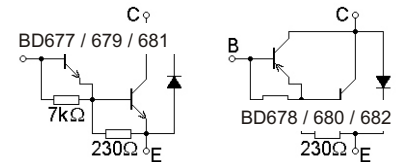
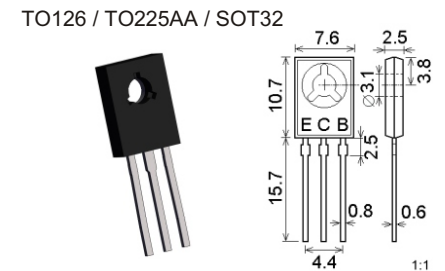

### Bipolární Tranzistory - parametry

**Uce (V)** - nejvyšší dovolené napětí kolektor - emitor

**Uces(V)** - saturační napětí kolektor-emitor

**Ic (A)** - nejvyšší dovolený proud kolektoru

**P (W)** - nejvyšší dovolená výkonová ztráta

**B** - stejnosměrný zesilovací činitel

**G (dB)** - zisk

**f (MHz)** - nejvyšší pracovní kmitočet

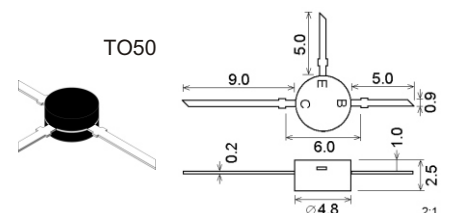

## Tranzistory nf SMD

objednací název		Uce	Ic	P	B	f	Uces	pouzdro
NPN	PNP	V	A	W		MHz	V	
BC848W SMD	BC858W SMD	30	0.1	0.2	110~800	100	0.2	SOT323
■ BC846W SMD		65	0.1	0.2	110~450	100	0.2	SOT323
BC846BW SMD	■ BC856BW SMD	65	0.1	0.2	200~450	100	0.2	SOT323
■ BC848B SMD		30	0.1	0.25	200~450	100	0.6	SOT23
■ BC848C SMD		30	0.1	0.23	420~800	100	0.6	SOT23
■ PMBT3904 SMD	■ PMBT3906 SMD	40	0.2	0.25	30~300	300	0.3	SOT23
■ BC847A SMD	■ BC857A SMD	45	0.1	0.25	110~220	100	0.3	SOT23
■ BC847C SMD	■ BC857C SMD	45	0.1	0.25	420~800	100	0.3	SOT23
■ BC847B SMD	■ BC857B SMD	45	0.1	0.25	200~450	100	0.2	SOT23
BC850C SMD	BC860C SMD	45	0.1	0.25	420~800	100	0.2	SOT23
	■ BC807-16 SMD	45	0.5	0.3	100~250	100	0.7	SOT23
■ BC817-25 SMD	■ BC807- 25 SMD	45	0.5	0.31	160~400	80	0.7	SOT23
■ BC817-40 SMD	■ BC807- 40 SMD	45	0.5	0.31	250~600	80	0.7	SOT23
■ BC846B SMD	■ BC856B SMD	65	0.1	0.31	200~450	150	0.3	SOT23
	■ BC856A SMD	65	0.1	0.25	125~250	100	0.65	SOT23
FMMT458TA		400	0.23	0.5	100~300	50	0.5	SOT23
	FMMT560TA	500	0.15	0.5	80~300	60	0.5	SOT23
■ BCX41 SMD	■ BCX42 SMD	125	0.8	0.33	> 25	100	0.9	SOT23
■ BCX54-16 SMD	■ BCX51-16 SMD	45	1.5	1	100~250	100	0.5	SOT89
■ BCX55-16 SMD	■ BCX52-16 SMD	60	1.5	1	100~250	100	0.5	SOT89
■ BCX56-16 SMD	■ BCX53-16 SMD	80	1.5	1	100~250	100	0.5	SOT89
■ BCP55-16 SMD	■ BCP52-16 SMD	60	1	1.3	100~250	115	0.5	SOT223
	■ BCP56-16 SMD	80	1	1.5	100~250	130	0.5	SOT223
	■ BCP53-16 SMD	80	1.5	1.5	100~250	50	0.5	SOT223
■ BDP949 SMD	BDP950 SMD	60	3	5	15~475	100	0.5**	SOT223
	■ BC858B SMD	30	0.1	0.25	220~475	100	0.65	SOT23
	■ BC858C SMD	30	0.1	0.23	420~800	100	0.65	SOT23
■ MMBT2222A SMD		40	0.6	0.25*	> 35	250	1	SOT23
	■ MMBT2907A SMD	60	0.6	0.35	50~300	200	1.6	SOT23
■ MMBT3904 SMD		40	0.2	0.35*	> 30	300	0.3	SOT23
	■ MMBT3906 SMD	40	0.2	0.25*	30~300	250	0.4	SOT23
# MMBTA05 SMD		60	0.5	0.3	> 100	100	0.25	SOT23
■ BDP947 SMD		45	3	5	15/475	100	0.5	SOT223

\* montáž pájecích vývodů na měděnou desku o ploše 3mm<sup>2</sup>

\*\* impulzní test: t < 300us; D < 2%

SOT323 / SC70

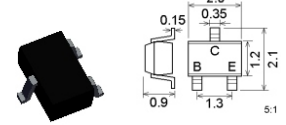

SOT23 / TO236AB

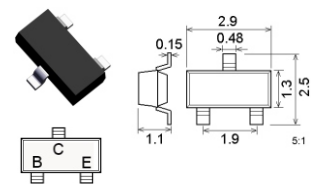

SOT89 / TO243AA

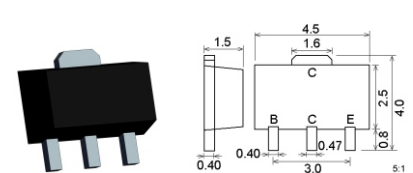

## Tranzistory Darlington SMD

objednací název		Uce	Ic	P	B	f	Uces	pouzdro
NPN	PNP	V	A	W		MHz	V	
■ BCV47 SMD	■ BCV46SMD	60	0.5	0.36	> 20 000	> 170	1	SOT23
■ BCV27 SMD	■ BCV26 SMD	30	0.8	0.35	> 20 000	220	1	SOT23
PZTA14 SMD		30	0.5	1.25*	> 10 000	125	1.5	SOT223
	■ BSP60 SMD	45	1	1.25*	> 1 000**	200	1.3	SOT223
■ BSP52 SMD		80	1	0.8	> 1 000		1.3	SOT223
	■ BSP62 SMD	80	1	1.5	> 1 000***	200	1.3***	SOT223
■ BST52 SMD		80	0.5	1.3****	> 1 000	200	1.3	SOT89

\* montáž na DPS FR4, jednostranná měď, pocínováno, montážní podložka pro kolektor 1cm<sup>2</sup>

\*\* impulzní test: t<sub>p</sub> 300 s; < 0.02

\*\*\* impulzní test: t < 300us; D < 2%

\*\*\*\* DPS, jednostranná měď, pocínováno, montážní podložka pro kolektor 6cm<sup>2</sup>

SOT223 / TO261AA

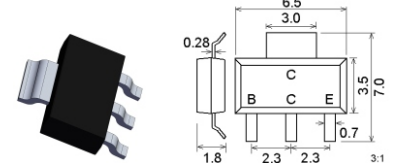

## Tranzistory nf vysokonapět'ové SMD

objednací název		Uce	Ic	P	B	f	Uces	pouzdro
NPN	PNP	V	A	W		MHz	V	
■ BFN26 SMD	■ BFN27 SMD	300	0.2	0.36	> 25	70	0.4	SOT23
	■ MMBTA92LT1G SMD	300	0.5	0.23	> 25	50	0.5	SOT23
■ MMBTA42 SMD	■ MMBTA92LT1 SMD	300	0.5	0.3	> 25	50	0.5	SOT23
■ SMBTA42 SMD	■ SMBTA92 SMD	300	0.5	0.36	> 25	> 50	0.5	SOT23

## Tranzistory s vestavěnými rezistory (BRT) SMD

objednávací název		Uce	Ic	P	B	f	Uces	R1	R2	pouzdro
NPN	PNP	V	mA	W		MHz	V	k	k	
DTC143ZET1G SMD		50	100	0.2	200		0.25	4.7	47	SOT416
	DTA124ECA SMD	50	30	0.2	>56	250		22	22	SOT23
	DTA114ECA SMD	50	50	0.2	>30	250		10	10	SOT23
BCR112 SMD		50	100	0.2	>20	140	0.3	4.7	4.7	SOT23
BCR133 SMD		50	100	0.2	>30	130	0.3	10	10	SOT23
	DTA143ECA SMD	50	100	0.2	>30	250		4.7	4.7	SOT23
DTC114ECA SMD		50	100	0.2	>30	250		10	10	SOT23
DTC143XCA SMD		50	100	0.2	>30	250		4.7	10	SOT23
DTC113ZCA SMD		50	100	0.2	>33	250		1	10	SOT23
	BCR191 SMD	50	100	0.2	>50	200	0.3	22	22	SOT23
DTC144ECA SMD	DTA144ECA SMD	50	100	0.2	>68	250		47	47	SOT23
BCR135 SMD		50	100	0.2	>70	150	0.3	10	47	SOT23
BCR142 SMD		50	100	0.2	>70	150	0.3	22	47	SOT23
BCR108 SMD		50	100	0.2	>70	170	0.3	2.2	47	SOT23
BCR158 SMD		50	100	0.2	>70	200	0.3	2.2	47	SOT23
	BCR185 SMD	50	100	0.2	>70	200	0.3	10	47	SOT23
DTC123JCA SMD	DTA123JCA SMD	50	100	0.2	>80	250		2.2	47	SOT23
	BCR169 SMD	50	100	0.2	120-630	200	0.3	4.7		SOT23
BCR141 SMD		50	100	0.25	>50	130	0.3	22	22	SOT23
BCR512 SMD		50	500	0.33	>60	100	0.3	4.7	4.7	SOT23
BCR505 SMD		50	500	0.33	>70	100	0.3	2.2	10	SOT23
BCR523 SMD		50	500	0.33	>70	100	0.3	1	10	SOT23
	BCR555 SMD	50	500	0.33	>70	150	0.3	2.2	10	SOT23
	BCR562 SMD	50	500	0.33	>60	150	0.3	4.7	4.7	SOT23
BCR108W SMD		50	100	0.2	>70	170	0.3	2.2	47	SOT323
BCR133W SMD		50	100	0.25	>30	130	0.3	10	10	SOT323
BCR148W SMD		50	100	0.25	>70	100	0.3	47	47	SOT323
BCR135W SMD		50	100	0.25	>70	150	0.3	10	47	SOT323

SOT416 / SC75

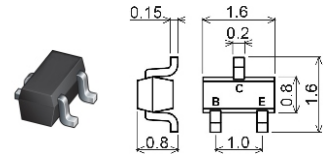

SOT323 / SC70

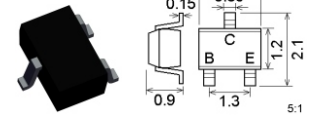

SOT363 / SC88 / SC70-6

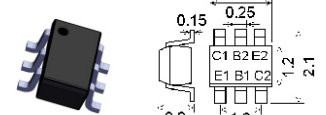

## Dvojice tranzistorů nf SMD

objednávací název	Uce	Ic	P	B	f	Uces	pouzdro
NPN	V	mA	W		MHz	V	
UMH11N SMD	50	50	0.15	>30	250		SOT363
BC846S SMD	65	100	0.2	>110	100	0.3	SOT363

SOT23 / TO236AB

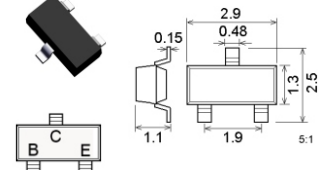

## Tranzistory vf do 1GHz SMD

objednávací název		Uce	Ic	P	B	f	Uces	pouzdro
NPN	PNP	V	mA	W		MHz	V	
	MMBTH81 SMD	20	50	0.23	>60	600	0.5	SOT23
	MMBTH10LT1G SMD	25		0.23	>60	650	0.5	SOT23
	MMBTH24 SMD	30	50	0.23*	>30	400		SOT23

\* montáž na FR-4 1.6"x1.6"x0.06"

SOT143 / TO253AA

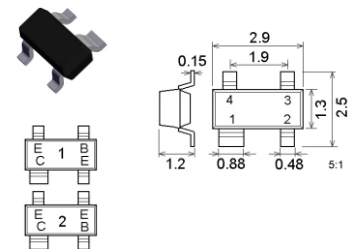

## Tranzistory vf nad 1GHz SMD

objednávací název		Uce	Ic	P	G	f	pouzdro
NPN		V	mA	W	dB	GHz	
#	BFS17P SMD	15	25	0.3	10	2.5	SOT23
	BFT92 SMD	15	25	0.3	8	5	SOT23
	BFR92A SMD	15	25	0.3	14	5	SOT23
	BFT93 SMD	12	35	0.3	16.5	5	SOT23
	BFR106 SMD	16	210	0.7	8.5	5	SOT23
	BFR93A SMD	12	35	0.3	13	6	SOT23
	BFR193 SMD	12	80	0.58	10	8	SOT23
	AT41511T SMD	12	50	0.2	15.5	8	SOT143(1)
	BFG67 SMD	10	50	0.3	17	8	SOT143(2)
	BFG540W SMD	15	120	0.5	10	9	SOT343N
	BFG425W SMD	4.5	25	0.14	20	25	SOT343R

SOT343N / SOT343R / SC82

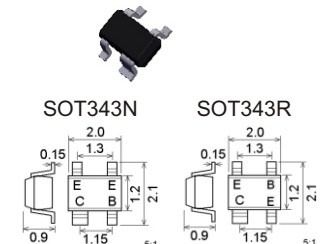

### Bipolární Tranzistory - parametry

**Uce (V)** - nejvyšší dovolené napětí kolektor - emitor

**Uces(V)** - saturační napětí kolektor-emitor

**Ic (A)** - nejvyšší dovolený proud kolektoru

**P (W)** - nejvyšší dovolená výkonová ztráta

**B** - stejnosměrný zesilovací činitel

**G (dB)** - zisk

**f (MHz)** - nejvyšší pracovní kmitočet

■ součástka se doplňuje na sklad | # součástka na skladě, výprodej | novinka = **zelené podbarvení** | Dodací podmínky neoznačených součástek sdělíme na poptávku

## Tranzistory MOSFET do 1.5W

objednáací název	kanál	U <sub>ds</sub>	I <sub>d</sub>	P	R <sub>ds</sub>	t <sub>on/off</sub>	pouzdro
kanál N		V	mA	W		ns	
■ BS250P	P	45	230	0.7	14	20 / 20	TO92 (8)
■ VN2222LL-G	N	60	230	1	7.5	10 / 10	TO92 (8)
■ 2N7008-G	N	60	230	1	7.5	20 / 20	TO92 (8)
■ VP2106N3-G	P	60	250	1	12	4 / 5	TO92 (8)
■ BSS98	N	50	300	0.63	6	5 / 12	TO92 (6)
■ TN2106N3-G	N	60	300	0.74	2.5	3 / 6	TO92 (8)
■ VN0808L-G	N	80	300	1	4	10 / 10	TO92 (8)
■ VN10KN3-G	N	60	310	1	5	10 / 10	TO92 (8)
■ VN0606L-G	N	60	330	1	3	10 / 10	TO92 (8)
■ VN0104N3-G	N	40	350	1	3	3 / 6	TO92 (8)
■ VN0106N3-G	N	60	350	1	3	3 / 6	TO92 (8)
■ BS170	N	60	500	0.83	5	10 / 10	TO92 (6)
■ VP0104N3-G	P	40	800	1	8	4 / 8	TO92 (8)
■ VN2210N3-G	N	100	1200	0.74	0.5	10 / 50	TO92 (8)
■ IRFD9120	P	100	1000	1.3	0.6	40 / 50	HVMDIP
■ IRFD110	N	100	1000	1.3	0.54	6.9 / 15	HVMDIP
■ IRLD110	N	100	1000	1.3	0.54	9.3 / 16	HVMDIP
■ IRFD120	N	100	1300	1.3	0.27	6.8 / 18	HVMDIP
■ IRFD9024	P	60	1600	1.3	0.28	13 / 15	HVMDIP
■ IRFD014	N	60	1700	1.3	0.2	10 / 13	HVMDIP
■ IRLD024	N	60	2500	1.3	0.1	11 / 23	HVMDIP

TO92 / SC43 / SOT54

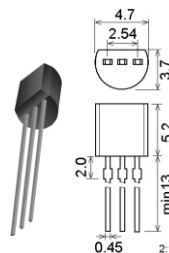

Pouzdra TO92 balená v pásu tj. T/B příp. T/R mají zpravidla dvojnásobnou rozteč mezi vývody (okrajové nožičky jsou vyhnuté do stran)

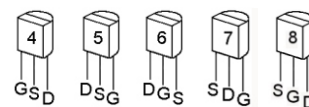

## Tranzistory MOSFET vysokonapět'ové do 1.5W

objednáací název	kanál	U <sub>ds</sub>	I <sub>d</sub>	P	R <sub>ds</sub>	t <sub>on/off</sub>	pouzdro
kanál N		V	mA	W		ns	
■ BS108	N	200	250	0.35	8	15 / 15	TO92 (6)
■ VN2406L-G	N	240	190	1	6	8 / 23	TO92 (8)
■ VN2410L-G	N	240	190	1	10	8 / 23	TO92 (8)
■ TN5325N3-G	N	250	215	0.74	8	20 / 25	TO92 (8)
■ TP2635N3-G	P	350	180	1	15	10 / 60	TO92 (8)
■ DN2540N3-G	N	400	150	1	25	10 / 15	TO92 (8)
■ LND150N3-G	N	500	30	0.74	1000	90 / 100	TO92 (8)
■ IRFD9210	P	200	400	1	3	8 / 11	HVMDIP
■ IRFD220	N	200	800	1	0.8	7.2 / 19	HVMDIP

HVMDIP

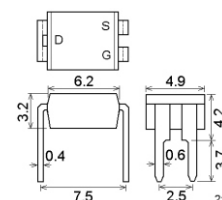

## Tranzistory MOSFET výkonové kanál N

objednáací název	kanál	U <sub>ds</sub>	I <sub>d</sub>	P	g <sub>fs</sub>	ton/off	R <sub>dson</sub>	pouzdro
kanál N		V	A	W	S	ns	m	
■ IRFU120N	N	100	9.4	48	2.7	4.5 / 32	210	IPAK
■ IRLU024N	N	55	17	45	8.3	7.1 / 20	65	IPAK
■ IRLU2703	N	30	20	45	6.4	8.5 / 12	45	IPAK
■ IRLU2905	N	55	20	110	21	11 / 26	27	IPAK
■ IRLU2905Z	N	55	42	110	25	14 / 24	13.5	IPAK
■ IRLU3705Z	N	55	42	130	89	17 / 33	8	IPAK
■ IRLU3110Z	N	100	42	140	52	24 / 33	14	IPAK
# IRLU8259	N	25	42	48	55	8.4 / 9.1	12.9	IPAK
# IRLU8256	N	25	50	63	81	9.7 / 12	5.7	IPAK
# IRLU8729	N	30	50	55	91	10 / 11	8.9	IPAK
# IRLU8726	N	30	50	75	73	12 / 15	5.8	IPAK
■ IRLU8743	N	30	50	135	89	19 / 21	3.1	IPAK
■ IRFU4510	N	100	56	143	62	18 / 42	13.9	IPAK
■ IRFU7440	N	40	90	140	280	11 / 51	2.4	IPAK
# IRFU1010Z	N	55	42	140	31	17 / 42	7.5	IPAK
■ IRFU1018E	N	60	56	110	110	13 / 55	8.4	IPAK
■ IRFU3607	N	75	56	140	115	16 / 43	9	IPAK

IPAK / TO251AA

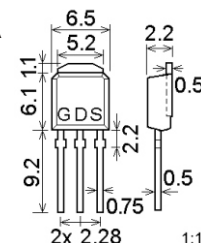
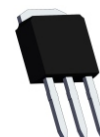

### FET tranzistory - parametry

**P (W)** - nejvyšší dovolená výkonová ztráta na tranzistoru

**f (MHz)** - nejvyšší pracovní kmitočet tranzistoru

**U<sub>ds</sub> (V)** - nejvyšší dovolené stejnosm. napětí Drain - Source

**I<sub>d</sub> (A)** - nejvyšší dovolený proud elektrodou Drain

**R<sub>ds</sub> ( )** - odpor Drain - Source v sepnutém stavu

**t<sub>on/off</sub> (ns)** - čas sepnutí / vypnutí; (*ONdelay+rise* / *OFFdelay+fall*)

■ součástka se doplňuje na sklad | # součástka na skladě, výprodej | novinka = **zelené podbarvení** | Dodací podmínky neoznačených součástek sdělíme na požádání



## Tranzistory MOSFET výkonové kanál N

objednáací	název	kanál	U <sub>ds</sub>	I <sub>d</sub>	P	g <sub>fs</sub>	ton/off	R <sub>ds(on)</sub>	pouzdro
			V	A	W	S	ns	m	
■	IRF510	N	100	5.6	43	1.3	6.9 / 15	540	TO220
■	IRF520	N	100	9.2	60	2.7	40 / 40	270	TO220
■	IRF520N	N	100	9.7	48	2.7	4.5 / 32	200	TO220
■	IRL520N	N	100	10	48	3.1	4 / 23	180	TO220
■	IRF530	N	100	14	88	5.1	10 / 23	160	TO220
■	IRFZ24N	N	55	17	45	4.5	40 / 50	70	TO220
■	IRLZ24N	N	55	18	45	8.3	80 / 50	60	TO220
■	IRF530N	N	100	17	70	12	9.2 / 35	90	TO220
■	IRL530N	N	100	17	79	7.7	7.2 / 30	100	TO220
■	IRFB4212	N	100	18	60	11	7.7 / 14	72.5	TO220
■	IRFZ34N	N	55	29	68	6.5	60 / 70	40	TO220
■	BUZ11	N	50	30	75	8	100 / 300	40	TO220
■	IRLZ34N	N	55	30	68	11	8.9 / 21	35	TO220
■	IRF540N	N	100	33	130	21	45 / 80	44	TO220
■	IRL540N	N	100	36	140	14	90 / 100	44	TO220
■	IRF540Z	N	100	36	92	36	15 / 43	26.5	TO220
■	IRFZ46N	N	55	39	107	19	14 / 52	16.5	TO220
■	IRF3709Z	N	30	42	79	88	13 / 16	6.3	TO220
■	IRL8113	N	30	42	110	86	14 / 18	6	TO220
■	IRF1310N	N	100	42	160	14	11 / 45	36	TO220
■	IRFB3806	N	60	43	71	41	6.3 / 49	15.8	TO220
■	IRLZ44N	N	55	47	110	21	95 / 40	22	TO220
■	IRFZ44N	N	55	49	94	19	70 / 80	17.5	TO220
■	IRFZ44E	N	60	48	110	15	12 / 70	23	TO220
■	IRFZ44Z	N	55	51	80	22	14 / 33	13.9	TO220
■	IRLZ44Z	N	55	51	80	27	14 / 25	13.5	TO220
■	IRFZ44V	N	60	55	115	24	13 / 40	16.5	TO220
■	IRL2910	N	100	55	200	28	11 / 49	26	TO220
■	IRF3710	N	100	57	200	32	70 / 100	23	TO220
■	IRF3710Z	N	100	59	160	35	17 / 41	18	TO220
■	IRLB8721	N	30	62	65	35	9.1 / 9.0	8.7	TO220
■	IRF3708	N	30	62	87	49	7.2 / 17.6	12	TO220
■	IRFB4510	N	100	62	140	100	13 / 28	13.5	TO220
■	IRL3103	N	30	64	94	22	8.9 / 14	12	TO220
■	IRFZ48N	N	55	64	130	24	90 / 85	14	TO220
■	IRL7833	N	30	75	140	150	18 / 21	4.5	TO220
■	IRL2203N	N	30	75	180	73	11 / 23	7	TO220
■	IRF3703	N	30	75	230	150	18 / 53	2.8	TO220
■	IRF2804	N	40	75	300	130	13 / 130	2	TO220
■	IRF1010Z	N	55	75	140	33	18 / 36	7.5	TO220
■	IRF3205Z	N	55	75	170	71	18 / 45	6.5	TO220
■	IRF3205	N	55	75	200	44	115 / 115	8	TO220
■	IRF1405	N	55	75	330	69	203 / 240	5.3	TO220
■	IRFB3256	N	60	75	300	88	22 / 55	3.4	TO220
■	IRF3808	N	75	75	330	100	16 / 68	7	TO220
■	IRFB4710	N	100	75	200	35	35 / 41	14	TO220
■	IRF8010	N	100	75	260	82	15 / 61	15	TO220
■	IRLB8748	N	30	78	75	196	14 / 16	4.8	TO220
■	IRLB8743	N	30	78	140	190	23 / 25	3.2	TO220
■	IRF1018E	N	60	79	110	110	13 / 55	84	TO220
■	STP120N4F6	N	40	80	110		90 / 60	4.3	TO220
■	SPP80N06S2L-07	N	55	80	210	104	55 / 60	7	TO220
■	IRFB3607	N	75	80	140	115	16 / 43	9	TO220

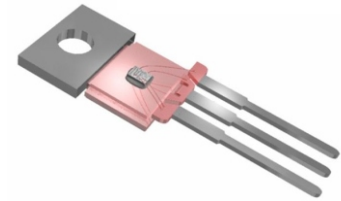
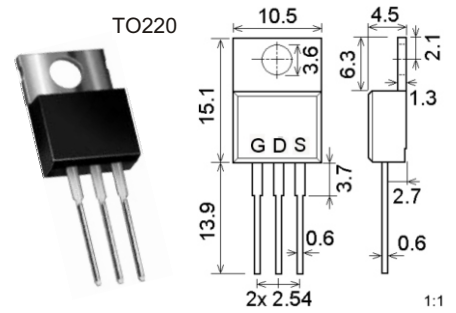

Čip tranzistoru MOSFET v nezakrytém pouzdře TO220

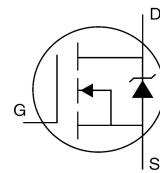

Schematická značka tranzistoru MOSFET kanál N se substrátovou ochrannou diodou

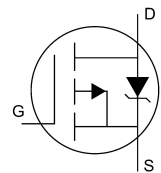

Schematická značka tranzistoru MOSFET kanál P se substrátovou ochrannou diodou

### FET tranzistory - parametry

**P (W)** - nejvyšší dovolená výkonová ztráta na tranzistoru

**f (MHz)** - nejvyšší pracovní kmitočet tranzistoru

**U<sub>ds</sub> (V)** - nejvyšší dovolené stejnosměrné napětí Drain - Source

**I<sub>dss</sub> (mA)** - proud elektrodou Drain pro U<sub>gs</sub>=0

**I<sub>d</sub> (mA)** - nejvyšší dovolený proud elektrodou Drain

**R<sub>ds</sub> ( )** - odpor Drain - Source v sepnutém stavu

**g<sub>fs</sub> (mS)** - strmost (vstupní admitance)

**t on/off (ns)** - čas sepnutí / vypnutí; (ONdelay+rise / OFFdelay+fall)

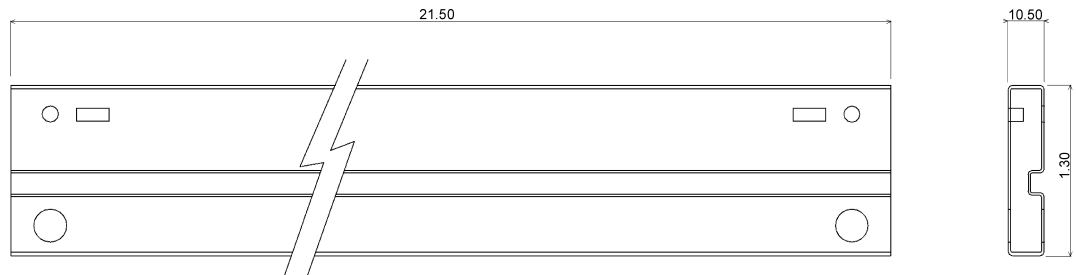

Příklad balení v němž jsou uloženy tranzistory s pouzdrem TO220 tzv. balení tube

## Tranzistory MOSFET výkonové kanál N

objednávací název	kanál	U <sub>ds</sub>	I <sub>d</sub>	P	g <sub>fs</sub>	ton/off	R <sub>dson</sub>	pouzdro
		V	A	W	S	ns	m	
■ IRF2807	N	75	82	230	38	13 / 49	13	TO220
■ IRF1010N	N	55	85	180	32	13 / 39	11	TO220
■ IRL3705N	N	55	89	170	50	12 / 37	10	TO220
■ IRFB4410Z	N	100	97	230	140	68 / 100	7.2	TO220
■ IRL2505	N	55	104	200	59	12 / 43	8	TO220
# AOT424	N	30	110	100	106	48 / 73	4	TO220
■ IRLB3813	N	30	120	230	140	36 / 33	2.6	TO220
■ IRF1404Z	N	40	120	200	170	18 / 36	3.7	TO220
■ IRL1404Z	N	40	120	230	120	19 / 30	3.1	TO220
■ IRL1404	N	40	120	230	120	19 / 30	4	TO220
■ IRFB3306	N	60	120	230	230	15 / 40	4.2	TO220
■ IRFB3206	N	60	120	300	210	19 / 55	3	TO220
■ IRFB3307Z	N	75	120	230	320	15 / 38	5.8	TO220
■ IRFB3207Z	N	75	120	300	280	20 / 55	4.1	TO220
■ IRFB3077	N	75	120	370	160	25 / 69	3.3	TO220
■ IRFB4310Z	N	100	120	250	150	20 / 55	6	TO220
■ IRFB4110	N	100	120	370	160	25 / 78	4.5	TO220
■ IRL1004	N	40	130	200	63	16 / 25	6.5	TO220
■ IRL3803	N	30	140	200	55	244 / 64	6	TO220
■ IRF1324	N	24	195	300	180	17 / 83	1.5	TO220
■ IRFB7437	N	40	195	230	160	19 / 78	2	TO220
■ IRLB3034	N	40	195	375	286	65 / 97	1.7	TO220
■ IRFB3004	N	40	195	380	1170	23 / 90	1.75	TO220
■ IRFB3006	N	60	195	375	280	16 / 118	2.5	TO220
■ IRF1404	N	40	202	333	76	17 / 46	4	TO220

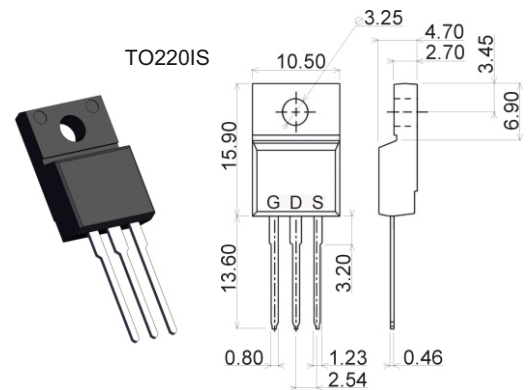
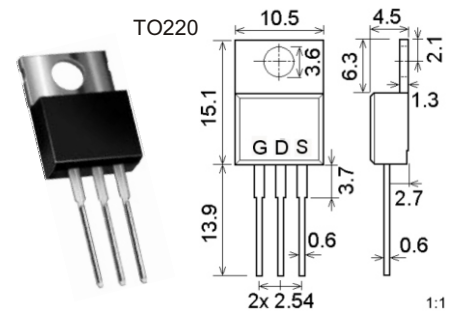

TO220IS - chladicí plech oddělen od vnějšího prostředí zalitím v plastovém izolantu (tl. zalitého plechu cca + 1mm)

## Tranzistory MOSFET výkonové kanál N

objednávací název	kanál	U <sub>ds</sub>	I <sub>d</sub>	P	g <sub>fs</sub>	ton/off	R <sub>dson</sub>	pouzdro
		V	A	W	S	ns	m	
■ IRFI530N	N	100	12	41	6.4	33 / 62	110	TO220IS
■ IRLI530N	N	100	12	41	7.7	60 / 55	100	TO220IS
■ IRFIZ24N	N	55	14	29	4.5	4.9 / 19	70	TO220IS
■ IRFI540N	N	100	20	54	11	50 / 75	52	TO220IS
■ IRFIZ44N	N	55	31	45	17	76 / 107	24	TO220IS
■ IRFIZ48N	N	55	40	54	22	11 / 32	16	TO220IS
■ IRFI1010N	N	55	49	58	30	11 / 40	12	TO220IS
■ IRFI3205	N	55	64	63	42	14 / 43	8	TO220IS
■ IRLI3705NPBF	N	55	52	58	50	12 / 37	10	TO220IS
■ IRLI540N	N	100	23	54	14	11 / 39	44	TO220IS
■ IRLIZ44NPBF	N	55	30	45	21	11 / 26	22	TO220IS
■ IRFP140N	N	100	33	140	11	8.2 / 44	52	TO247
■ IRFP150	N	100	41	230	13	16 / 60	55	TO247
■ IRFP150N	N	100	42	160	14	11 / 45	36	TO247
■ IRFP044N	N	55	53	120	16	12 / 43	20	TO247
■ IRFP3710	N	100	57	200	20	14 / 58	25	TO247
■ IRFP4710	N	100	72	190	35	35 / 41	14	TO247
■ IRFP054N	N	55	81	170	30	80 / 90	12	TO247
■ IRFP2907Z	N	75	90	310	180	19 / 97	4.5	TO247
■ IRFP2907	N	75	90	470	130	23 / 130	4.5	TO247
■ IRFP4410Z	N	100	97	230	140	16 / 43	7.2	TO247
■ IRFP064N	N	55	110	200	42	115 / 115	8	TO247
■ IRFP3306	N	60	120	220	230	90 / 120	4.2	TO247
■ IRFP3077	N	75	120	340	160	25 / 69	3.3	TO247
■ IRFP4310Z	N	100	120	280	150	20 / 55	6	TO247
■ IRFP4110	N	100	120	370	160	25 / 78	4.5	TO247
■ IRLP3034	N	40	195	341	286	65 / 97	1.7	TO247
■ IRFP4368	N	75	195	520	650	43 / 170	1.85	TO247
■ IRFP4468	N	100	195	520	310	52 / 160	2.6	TO247

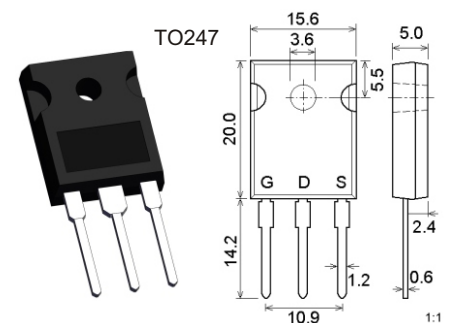

## Tranzistory MOSFET vysokonapět'ové výkonové kanál N

objednáací název	kanál	U <sub>ds</sub>	I <sub>d</sub>	P	g <sub>fs</sub>	ton/off	R <sub>dson</sub>	pouzdro
		V	A	W	S	ns	m	
■ IRFU4615	N	150	33	144	35	15 / 25	42	IPAK
■ IRFU220N	N	200	5	43	2.6	6.4 / 20	600	IPAK
■ IRFU4620	N	200	24	144	37	13.4 / 25.4	78	IPAK
■ IRFU420	N	500	2.4	42	1.5	20 / 50	3000	IPAK
■ SPU02N60C3	N	650	1.8	25	1.75	10 / 80	3000	IPAK
■ IRFB4019	N	150	17	80	14	7 / 12	80	TO220
■ IRF3315	N	150	23	94	17	9.6 / 49	70	TO220
■ IRFB5615	N	150	35	144	35	8.9 / 17.2	39	TO220
■ IRFB41N15D	N	150	41	200	18	16 / 25	45	TO220
■ IRF3415	N	150	43	200	19	12 / 71	42	TO220
■ IRFB4321	N	150	85	350	130	78 / 60	15	TO220
■ IRF610	N	200	3.3	36	0.8	8.2 / 8.9	1500	TO220
■ IRF620	N	200	5.2	50	1.5	7.2 / 19	800	TO220
■ IRF630	N	200	9	74	3.8	9.4 / 39	400	TO220
■ IRF630N	N	200	9.3	82	4.9	7.9 / 27	300	TO220
■ IRL640	N	200	17	125	16	90 / 95	180	TO220
■ IRFB4020	N	200	18	100	24	20 / 22	100	TO220
■ STP20NF20	N	200	18	110	13	45 / 50	125	TO220
■ IRF640N	N	200	18	150	6.8	10 / 23	150	TO220
■ IRFB4620	N	200	25	144	37	13.4 / 25.4	72.5	TO220
■ IRFB31N20D	N	200	31	200	17	16 / 26	82	TO220
■ IRFB38N20D	N	200	43	300	17	16 / 29	54	TO220
■ IRFB260N	N	200	56	380	29	17 / 52	40	TO220
■ IRFB4227	N	200	65	330	49	53 / 52	19.7	TO220
■ IRFB4332	N	250	60	390	100		33	TO220
■ DN2540N5-G	N	400	0.5	15	0.32	10 / 15	25000	TO220
■ IRF710	N	400	2	36	1	8 / 21	3600	TO220
■ IRF720	N	400	3.3	50	1.7	10 / 30	1800	TO220
■ IRF730	N	400	5.5	74	2.9	10 / 38	1000	TO220
■ STP11NK40Z	N	400	10	110		40 / 60	550	TO220
■ IRF740PBF	N	400	10	125	5.8	14 / 50	550	TO220
■ IRF820	N	500	2.5	50	1.5	17 / 49	3000	TO220
■ IRF830	N	500	4.5	74	2.5	24 / 58	1500	TO220
■ IRF840	N	500	8	125	4.9	40 / 70	850	TO220
■ IRFB812	N	500	3.6	78	7.6	14 / 24	2200	TO220
■ SPP03N60S5	N	600	3.2	38	1.8	60 / 55	1400	TO220
■ IRFBC40	N	600	6.2	125	4.7	13 / 55	1200	TO220
■ STP10NK60Z	N	600	10	115	7.8	40 / 85	750	TO220
■ AOT10N60	N	600	10	250	15	28 / 76	750	TO220
■ IRFBE30	N	800	4.1	125	2.5	12 / 82	3000	TO220
■ STP5NK80Z	N	800	4.3	110	4.25	45 / 75	1900	TO220
■ STP3NK90Z	N	900	3	90		25 / 63	4800	TO220
■ IRFBG20	N	1000	1.4	54	1	9.4 / 58	11000	TO220
■ IRFBG30	N	1000	3.1	125	2.1	40 / 120	5000	TO220
■ STP5NK100Z	N	1000	3.5	125	4	30 / 70	3700	TO220
■ IRFI740G	N	400	5.4	40	3.6	14 / 54	550	TO220IS
■ IRFI840G	N	500	4.6	40	3.7	14 / 55	850	TO220IS
■ AOTF7T60P	N	600	7	38	5.5	72 / 56	1100	TO220IS
■ AOTF8N60	N	600	8	50	12.5	93 / 120	900	TO220IS
■ STF3NK80Z	N	800	2.5	25		44 / 76	4500	TO220IS

IPAK / TO251AA

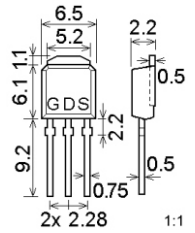
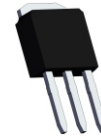

TO220

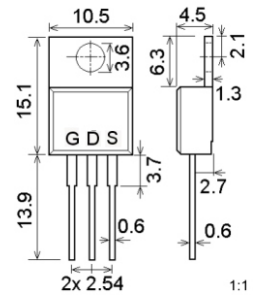

TO220IS

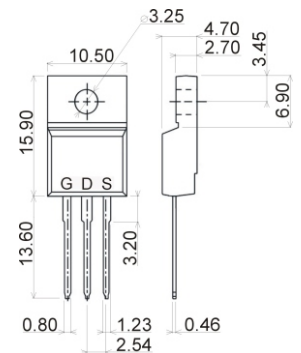
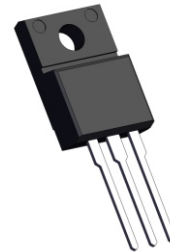

TO220IS - chladičí plech oddělen od vnějšího prostředí zalitím v plastovém izolantu (tl. zalitého plechu cca + 1mm)



## Tranzistory MOSFET vysokonapět'ové výkonové kanál N

objednáací název	kanál	U <sub>ds</sub>	I <sub>d</sub>	P	g <sub>fs</sub>	ton/off	R <sub>dson</sub>	pouzdro
		V	A	W	S	ns	m	
■ IRFP4321	N	150	78	310	130	18 / 25	15.5	TO247
■ IRFP4568	N	150	171	517	162	145 / 130	4.8	TO247
■ IRFP240	N	200	20	150	6.9	14 / 45	180	TO247
■ IRFP250N	N	200	30	214	17	14 / 41	75	TO247
■ IRFP260N	N	200	50	300	27	80 / 100	40	TO247
■ IRFP4227	N	200	65	330	49	33 / 21	25	TO247
■ IRFP90N20D	N	200	90	580	39	23 / 43	23	TO247
■ IRFP4668	N	200	130	520	150	41 / 64	8	TO247
■ IRFP264	N	250	38	280	20	22 / 110	75	TO247
■ IRFP4229	N	250	44	310	83	25 / 44	38	TO247
■ IRFP4332	N	250	57	57	100		33	TO247
■ IRFP350	N	400	16	190	10	16 / 87	300	TO247
■ IRFP360	N	400	23	280	14	18 / 100	200	TO247
■ IRFP450	N	500	14	190	9.3	17 / 92	400	TO247
■ IRFP460LC	N	500	20	280	12	100 / 80	270	TO247
■ IRFP22N50A	N	500	22	277	12	26 / 47	230	TO247
■ IRFPC50	N	600	11	180	5.7	18 / 88	600	TO247
■ IRFPC60	N	600	16	280	13	19 / 110	400	TO247
■ IRFPE50	N	800	7.8	190	5.6	19 / 120	1200	TO247
■ IRFPF50	N	900	6.7	190	4.9	20 / 130	1600	TO247
■ IRFPG50	N	1000	6.1	190	5.4	19 / 130	2000	TO247

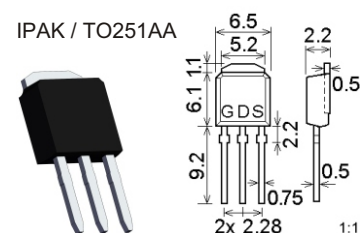
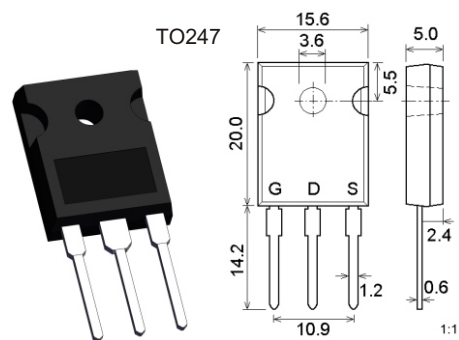

## Tranzistory MOSFET výkonové kanál P

objednáací název	kanál	U <sub>ds</sub>	I <sub>d</sub>	P	g <sub>fs</sub>	ton/off	R <sub>dson</sub>	pouzdro
		V	A	W	S	ns	m	
■ IRFU9024N	P	55	11	38	2.5	70 / 60	175	IPAK
■ IRFU5410	P	100	13	66	3.2	15 / 45	205	IPAK
■ IRFU5505	P	55	18	57	4.2	12 / 20	110	IPAK
■ IRF9510	P	100	4	43	1	10 / 15	1200	TO220
■ IRF9520	P	100	6.8	60	2	40 / 46	600	TO220
■ IRF9520N	P	100	6.8	48	1.4	60 / 60	480	TO220
■ IRF9Z24N	P	55	12	45	2.5	70 / 60	175	TO220
■ IRF9530NPBF	P	100	14	79	3.2	75 / 90	200	TO220
■ IRF9Z34N	P	55	19	68	4.2	13 / 30	100	TO220
■ IRF9540	P	100	19	150	6.2	80 / 80	200	TO220
■ IRF9540N	P	100	23	140	5.3	15 / 51	117	TO220
■ IRF5305	P	55	31	110	8	14 / 39	60	TO220
■ IRF5210	P	100	40	200	10	103 / 160	60	TO220
■ IRF4905	P	55	74	200	21	120 / 155	20	TO220
■ IRFP9140	P	100	21	180	6.2	16 / 34	200	TO247
■ IRFP9140N	P	100	23	140	5.3	15 / 51	117	TO247

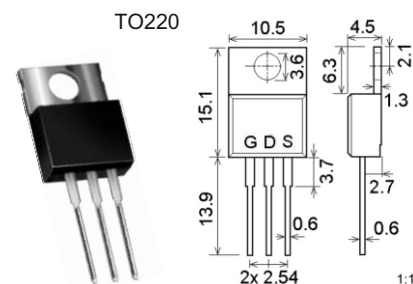

## Tranzistory MOSFET vysokonapět'ové výkonové kanál P

objednáací název	kanál	U <sub>ds</sub>	I <sub>d</sub>	P	g <sub>fs</sub>	ton/off	R <sub>dson</sub>	pouzdro
		V	A	W	S	ns	m	
■ IRF9610	P	200	1.8	20	0.9	8 / 10	3000	TO220
■ IRF9630	P	200	6.5	74	2.8	12 / 28	800	TO220
■ IRF9640	P	200	11	125	4.1	60 / 80	500	TO220
■ IRFP9240	P	200	12	150	4.2	14 / 39	500	TO247

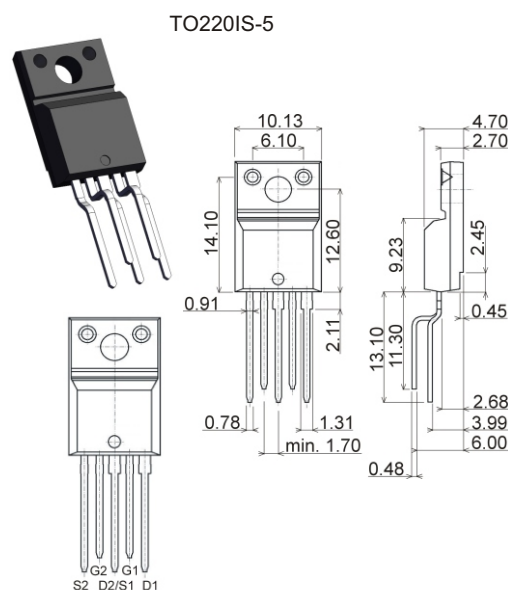

## Dvojice výkonových tranzistorů MOSFET kanál N

objednáací název	kanál	U <sub>ds</sub>	I <sub>d</sub>	P	g <sub>fs</sub>	ton/off	R <sub>dson</sub>	pouzdro
		V	A	W	S	ns	m	
# IRFI4024H-117P	2x N	55	11	14	6.5	5.9 / 13	48	TO220IS-5
■ IRFI4212H-117P	2x N	100	11	18	11	4.7 / 9.5	58	TO220IS-5

## Tranzistory MOSFET s ochranou elektrody G (ESD)

objednáací název	kanál	U <sub>ds</sub>	I <sub>d</sub>	P	g <sub>fs</sub>	ton/off	R <sub>dson</sub>	pouzdro
		V	A	W	S	ns	m	
■ STW12NK90Z	N	900	11	230	11	31 / 88	880	TO247

G2 G1  
S2 D2/S1 D1

## Tranzistory MOSFET SMD do 1.5W

objednáací název	kanál	U <sub>ds</sub>	I <sub>d</sub>	P	g <sub>fs</sub>	ton/off	R <sub>dson</sub>	pouzdro
		V	A	W	S	ns	m	
■ FDV302P SMD	P	25	0.12	0.35	0.14	13 / 14	10000	SOT23 (3)
■ 2N7002 SMD	N	60	0.12	0.2	0.32	20 / 40	4300	SOT23 (3)
■ TP0610T-G	P	60	0.12	0.36	0.06	10 / 15	10000	SOT23 (3)
■ NDS0610 SMD	P	60	0.12	0.36	0.43	2.5 / 10	10000	SOT23 (3)
■ BSS84 SMD	P	50	0.13	0.25	0.05	4 / 24	5000	SOT23 (3)
■ BSS123 SMD	N	100	0.15	0.25	0.4	15 / 30	3200	SOT23 (3)
■ TP2104K1-G	P	40	0.16	0.36	0.2	4 / 5	10000	SOT23 (3)
■ BSS84P SMD	P	60	0.17	0.36	0.13	6.7 / 8.6	12000	SOT23 (3)
■ BSN20 SMD	N	50	0.17	0.83	0.17	8 / 16	2800	SOT23 (3)
■ BSS169 SMD	N	100	0.17	0.36	0.19	2.9 / 11	12000	SOT23 (3)
■ BSS138LT1 SMD	N	50	0.23	0.23	0.1	20 / 20	10000	SOT23 (3)
■ FDV301N SMD	N	25	0.22	0.35	0.2	9 / 7	5000	SOT23 (3)
■ BSS138 SMD	N	50	0.22	0.36	0.45	20 / 40	1800	SOT23 (3)
■ TN2106K1-G	N	60	0.28	0.36	0.4	3 / 6	2500	SOT23 (3)
■ BSS83P SMD	P	60	0.33	0.36	0.47	94 / 117	2000	SOT23 (3)
■ 2N7002K SMD	N	60	0.38*	0.42	0.08	1.5 / 3	2300	SOT23 (3)
■ FDV304P SMD	P	25	0.46	0.35	0.8	15 / 90	1100	SOT23 (3)
■ FDV303N SMD	N	25	0.68	0.35	1.5	12 / 30	450	SOT23 (3)
■ IRLML5103 SMD	P	30	0.76	0.54	0.44	10 / 23	1000	SOT23 (3)**
■ IRLML6302 SMD	P	20	0.78	0.54	0.56	30 / 45	600	SOT23 (3)
■ IRLML2402 SMD	N	20	1.2	0.54	1.3	12 / 15	250	SOT23 (3)
■ IRLML2803 SMD	N	30	1.2	0.54	0.87	3.9 / 9	250	SOT23 (3)**
■ BSS215P SMD	P	20	1.5	0.5	4.5	16 / 29	150	SOT23 (3)
■ FDN360P SMD	P	30	2	0.5	5	6 / 11	80	SOT23 (3)
# IRLML2030 SMD T/R	N	30	2.7	1.3	2.6	8 / 8	100	SOT23 (3)
■ IRLML0060 SMD	N	60	2.7	1.25	7.6	12 / 11	116	SOT23 (3)
■ TSM2301CX SMD	P	20	2.8	0.9	6.5	24 / 160	130	SOT23 (3)
# AO3413 SMD	P	20	3	1.4	12	43 / 109	80	SOT23 (3)
■ IRLML5203 SMD	P	30	3	1.25	3.1	30 / 140	98	SOT23 (3)
■ TSM3401CX SMD	P	30	3	1.25	7	10.8 / 22.5	90	SOT23 (3)
■ TSM2302CX SMD	N	20	3.2	1	19	5.4 / 16.4	95	SOT23 (3)
■ AO3406 SMD	N	30	3.6	1.4	11	6 / 34	50	SOT23 (3)
■ IRLML6402TR SMD	P	20	3.7	1.3	6	400 / 970	65	SOT23 (3)
■ PMV40UN2R SMD	N	30	3.7	1	10.9	9 / 34	36	SOT23 (3)
■ TSM2311CX SMD	P	20	4	0.9	9	22 / 45	85	SOT23 (3)
■ AO3401A SMD	P	30	4	1.4	17	10 / 50	50	SOT23 (3)
■ IRLML6246 SMD	N	20	4.1	1.3	10	9 / 17	46	SOT23 (3)
■ IRLML2502TR SMD	N	20	4.2	1.25	5.8	18 / 80	45	SOT23 (3)**
■ IRLML6401 SMD	P	12	4.3	1.3	86	43 / 460	50	SOT23 (3)
■ TSM2312CX SMD	N	20	4.9	0.75	40	15 / 48	33	SOT23 (3)
■ TSM2314CX SMD	N	20	4.9	1.25	40	0.5 / 13.5	100	SOT23 (3)
■ IRLML0030 SMD T/R	N	30	5.3	1.3	9.5	10 / 12	27	SOT23 (3)
■ AO3400A SMD	N	30	5.7	1.4	33	6 / 29	26.5	SOT23 (3)
# TSM3404CX SMD	N	30	5.8	0.75	25	7.4 / 20.4	43	SOT23 (3)
■ IRFML8244 SMD	N	25	5.8	1.25	10	5 / 12	24	SOT23 (3)
■ IRLML6244 SMD	N	20	6.3	1.3	17	13 / 31	21	SOT23 (3)
■ IRFL014N SMD	N	55	1.9***	1***	1.6	6.6 / 12	160	SOT223
■ IRL014N SMD	N	55	2***	1***	2.3	5.1 / 14	140	SOT223
■ IRFL024N SMD	N	55	2.8***	1***	3	8.1 / 22.2	75	SOT223
■ IRL024N SMD T/R	N	55	3.1	1	3.3	29 / 43	65	SOT223
■ IRL024Z SMD	N	55	3.8	1	5.1	6.2 / 35	40	SOT223
■ IRFL024Z SMD	N	55	5.1	1	6.2	30 / 50	58	SOT223
■ IRFL4105 SMD	N	55	3.7	1	3.8	7.1 / 19	45	SOT223

\* Ta=25°C

\*\* výrobce označuje toto pouzdro jako Micro3

\*\*\* montáž na desku FR-4

## Tranzistory MOSFET SMD s ochranou elektrody G (ESD)

objednáací název	kanál	U <sub>ds</sub>	I <sub>d</sub>	P	g <sub>fs</sub>	ton/off	R <sub>dson</sub>	pouzdro
		V	A	W	S	ns	m	
■ BSC060P03NS3EG	P	30	100	83	63	15 / 66	6	TDSON8

SOT23 / TO236AB

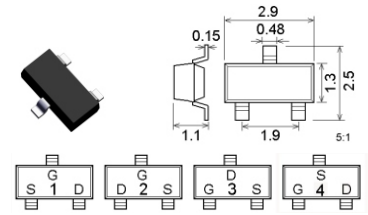

SOT223 / TO261AA

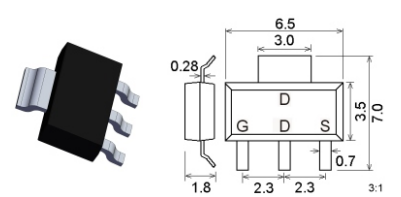

TDSON8

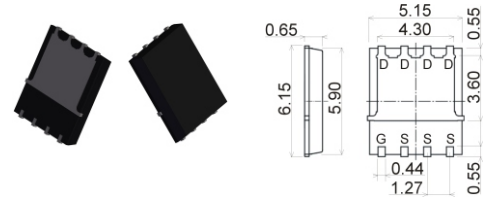

### FET tranzistory SMD - parametry

**P (W)** - nejvyšší dovolená výkonová ztráta na tranzistoru

**f (MHz)** - nejvyšší pracovní kmitočet tranzistoru

**U<sub>ds</sub> (V)** - nejvyšší dovolené stejnosměrné napětí Drain - Source

**I<sub>dss</sub> (mA)** - proud elektrodou Drain pro U<sub>gs</sub>=0

**I<sub>d</sub> (mA)** - nejvyšší dovolený proud elektrodou Drain

**R<sub>ds</sub> ( )** - odpor Drain - Source v sepnutém stavu

**g<sub>fs</sub> (mS)** - strmost (vstupní admitance)

**t on/off (ns)** - čas sepnutí / vypnutí; (ONdelay+rise / OFFdelay+fall)

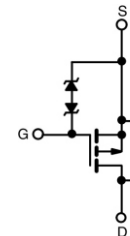

P-Channel MOSFET

ESD ochrana elektrody G

## Tranzistory MOSFET SMD do 5W

objednávací název	kanál	U <sub>ds</sub> V	I <sub>d</sub> A	P W	gfs S	ton/off ns	R <sub>ds(on)</sub> m	pouzdro
■ MCP87055T-U/LC	N	25	60	1.8	92	15 / 14	7	DFN8 (3x3)
■ MCP87022T-U/MF	N	25	100	2.2	155	35 / 38	2.6	DFN8 (5x6)
■ MCP87050T-U/MF	N	25	100	2.2	101	23 / 16	6	DFN8 (5x6)
# TSM2313CX SMD	P	20	3.3	2	11	22 / 45	130	SOT23
■ FDC608PZ SMD	P	20	5.8	1.6	22	13 / 91	30	TSOT23-6
■ IRF7205 SMD	P	30	4.6	2.5	6.6	14 / 97	70	SO8
■ AO4803A SMD	P	30	5	2	13	7.5 / 19	46	SO8
■ IRF7204 SMD	P	20	5.3	2.5	7.9	14 / 100	60	SO8
■ IRF7406 SMD	P	30	5.8	2.5	3.1	16 / 45	45	SO8
■ IRF7201 SMD	N	30	7.3	2.5	5.8	7 / 21	50	SO8
■ IRF7495 SMD	N	100	7.3	2.5	11	8.7 / 10	22	SO8
■ IRF7404 SMD	P	20	7.7	2.5	6.8	46 / 165	40	SO8
■ IRF7853 SMD	N	100	8.3	2.5	11	13 / 26	18	SO8
■ IRF7403 SMD	N	30	8.5	2.5	8.4	10 / 42	22	SO8
■ IRF7401 SMD	N	20	8.7	2.5	11	13 / 65	22	SO8
■ IRF7468 SMD	N	40	9.4	2.5	27	10 / 24	15.5	SO8
■ IRF7416 SMD	P	30	10	2.5	5.6	70 / 120	20	SO8
# AO4437 SMD	P	12	11	3	38	58 / 253	16	SO8
■ IRF7220 SMD	P	14	11	2.5	8.4	440 / 1200	12	SO8
■ IRF7413 SMD	N	30	13	2.5	10	60 / 100	10	SO8
■ IRF7425 SMD	P	20	15	2.5	44	33 / 390	8.2	SO8
■ IRF7455 SMD	N	30	15	2.5	44	17 / 51	7.5	SO8
■ IRF8788 SMD	N	30	24	2.5	95	23 / 23	2.8	SO8
■ IRF8252 SMD	N	25	25	2.5	89	23 / 19	2.7	SO8
■ IRF8707 SMD	N	30	11	2.5	25	6.7 / 7.3	11.9	SO8
■ IRF8721 SMD	N	30	14	2.5	27	8.2 / 8.1	8.5	SO8
■ IRF8736 SMD	N	30	18	2.5	52	12 / 13	4.8	SO8
■ IRF7862 SMD	N	30	21	2.5	87	16 / 18	3.7	SO8
■ IRF7831 SMD	N	30	21	2.5	97	18 / 17	3.6	SO8
■ IRF8734 SMD	N	30	21	2.5	85	29 / 23	0.0035	SO8
■ IRF7842 SMD	N	40	18	2.5	81	14 / 21	5	SO8
■ IRF7855 SMD	N	60	12	2.5	14	8.7 / 16	9.4	SO8
■ IRF7493 SMD	N	80	9.3	2.5	13	8.3 / 30	15	SO8
■ BSP296 SMD	N	100	1.1	1.8	1.2	13 / 59	0.7	SOT223
■ IRFL9110 SMD	P	100	1.1	3.1	0.82	10 / 15	1200	SOT223
■ BSP315P SMD	P	60	1.17	1.8	1.4	24 / 32	0.8	SOT223
■ IRL110 SMD	N	100	1.5	2	0.57	9.3 / 16	540	SOT223
■ IRFL110 SMD	N	100	1.5	3.1	1.1	6.9 / 15	540	SOT223
■ BSP295 SMD	N	60	1.8	1.8	1.7	5.4 / 27	300	SOT223
■ IRFL9014 SMD	P	60	1.8	3.1	1.3	11 / 9.6	500	SOT223
■ BSP170P SMD	P	60	1.9	1.8	2.6	14 / 92	300	SOT223
■ BSP171P SMD	P	60	1.9	1.8	2.7	6 / 208	300	SOT223
■ BSP318S SMD	N	60	2.6	1.8	5.5	12 / 20	90	SOT223
■ IRFL014 SMD	N	60	2.7	3.1	1.9	10 / 13	200	SOT223
■ BSP320S SMD	N	60	2.9	1.8	5.8	11 / 25	120	SOT223
■ STN3NF06L SMD	N	60	4	3.3		9 / 10	100	SOT223
■ TP2510N8-G	P	100	0.48	1.6	0.36	10 / 20	7000	SOT89 (1)
■ TN2510N8-G	N	100	0.73	1.6*	0.8	10 / 20	1500	SOT89 (1)
■ VN3205N8-G	N	50	1.5	1.6	1.5	10 / 25	300	SOT89 (1)

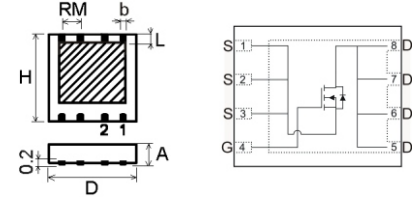
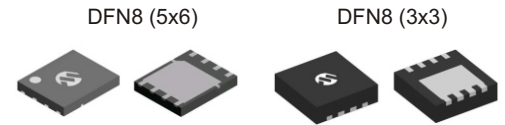

pouzdro	A	D	H	L	b	RM
	mm	mm	mm	mm	mm	mm
DFN8 (3x3)	1.00	3.0	3.0	0.40	0.30	0.65
DFN8 (5x6)	1.00	5.0	6.0	0.61	0.41	1.27

SOT23 / TO236AB

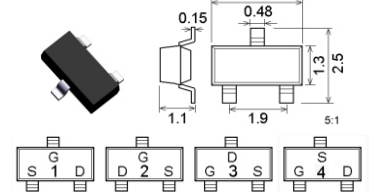

SO8

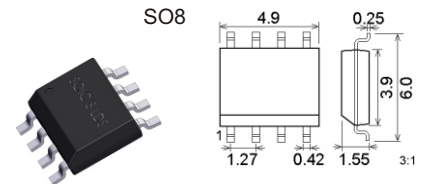

SOT223 / TO261AA

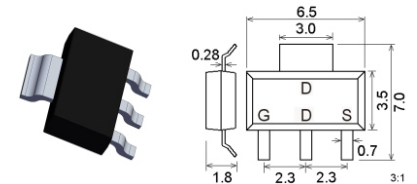

## Tranzistory MOSFET SMD vf do 1GHz

objednávací název	U <sub>ds</sub> V	I <sub>d</sub> A	P W	Pásmo	pouzdro
RD00HVS1-101	30	0.2	0.8	VHF / UHF	SOT89 (2)

TSOT23-6 / SuperSOT6

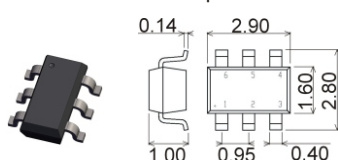

SOT89 / TO243AA

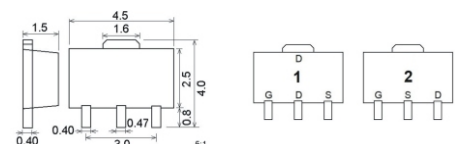

■ součástka se doplňuje na sklad | # součástka na skladě, výprodej | novinka = **zelené podbarvení** | Dodací podmínky neoznačených součástek sdělíme na poptávku

## Tranzistory MOSFET výkonové SMD kanál N

#	objednací název	kanál	U <sub>ds</sub>	I <sub>d</sub>	P	g <sub>fs</sub>	ton/off	R <sub>dson</sub>	pouzdro
			V	A	W	S	ns	m	
	SQS462EN-T1_GE3 SMD	N	60	8	33	11	6 / 12	63	1212-8
	IRF6648TR1 SMD	N	60	86	89	31	16 / 28	5.5	DirectFET
	IRFR110 SMD	N	100	4.3	25	1.6	6.9 / 15	540	DPAK
	IRLR110 SMD	N	100	4.3	25	2.3	9.3 / 16	540	DPAK
	IRFR014 SMD	N	60	7.7	25	2.4	10 / 13	200	DPAK
	IRFR120Z SMD	N	100	8.7	35	16	8.3 / 27	190	DPAK
	IRFR120N SMD	N	100	9.4	48	2.7	4.5 / 32	210	DPAK
	IRLR120N SMD	N	100	10	48	3.1	40 / 45	185	DPAK
	IRFR3910 SMD	N	100	16	79	6.4	6.4 / 37	115	DPAK
	IRFR024N SMD	N	55	17	45	4.5	4.9 / 19	75	DPAK
	IRLR024N SMD	N	55	17	45	8.3	80 / 50	65	DPAK
	IRLR3410 SMD	N	100	17	79	7.7	7.2 / 30	105	DPAK
	IRFR3303 SMD	N	30	20	57	9.3	11 / 16	31	DPAK
	IRLR3103 SMD	N	30	20	107	23	9 / 20	19	DPAK
	IRFR4105 SMD	N	55	20	68	6.5	7 / 31	45	DPAK
	IRFR1205 SMD	N	55	20	107	17	7.3 / 47	27	DPAK
	IRLR2905 SMD	N	55	20	110	21	11 / 26	27	DPAK
	IRLR2705 SMD	N	55	28	68	11	110 / 50	40	DPAK
	IRLR3715Z SMD	N	20	30	40	33	7.8 / 10	15.5	DPAK
	IRLR7807Z SMD	N	30	30	40	51	7.1 / 9.8	13.8	DPAK
	IRFR4105Z SMD	N	55	30	48	16	10 / 26	24.5	DPAK
	IRFR3709Z SMD	N	30	30	79	51	12 / 15	8.2	DPAK
	IRLR3717 SMD	N	20	30	89	49	14 / 5.8	4	DPAK
	IRFR2407 SMD	N	75	30	110	27	16 / 65	26	DPAK
	IRLR2908 SMD	N	80	30	120	35	12 / 36	28	DPAK
	IRFR3410 SMD	N	100	30	110	33	12 / 40	39	DPAK
	IRFR48Z SMD	N	55	42	91	120	15 / 40	11	DPAK
	IRFR2307Z SMD	N	75	42	110	30	16 / 44	16	DPAK
	IRLR3705Z SMD	N	55	42	130	89	17 / 33	8	DPAK
	IRFR4104 SMD	N	40	42	140	58	17 / 37	5.5	DPAK
	IRLR3114Z SMD	N	40	42	140	98	25 / 33	4.9	DPAK
	IRFR1010Z SMD	N	55	42	140	31	17 / 42	7.5	DPAK
	IRFR3806 SMD	N	60	43	71	41	45 / 95	15.8	DPAK
	IRLR8256 SMD	N	25	50	63	81	9.7 / 12	5.7	DPAK
	IRLR8743 SMD	N	30	50	135	89	19 / 21	3.1	DPAK
	IRFR1018E SMD	N	60	56	110	110	13 / 55	8.4	DPAK
	IRFR3607 SMD	N	75	56	140	115	16 / 43	9	DPAK
	IRFR4510TRPBF SMD	N	100	56	143	62	18 / 42	13.9	DPAK
	IRL520NS SMD	N	100	10	48	3.1	4 / 23	180	D2PAK
	IRF530NS SMD	N	100	17	70	12	9.2 / 35	90	D2PAK
	IRL530NS SMD	N	100	17	79	7.7	7.2 / 30	100	D2PAK
	IRF540NS SMD	N	100	33	130	21	11 / 39	44	D2PAK
	IRL540NS SMD	N	100	36	140	14	90 / 101	44	D2PAK
	IRF1310NS SMD	N	100	42	160	14	11 / 45	36	D2PAK
	IRF3415S SMD	N	150	43	200	19	12 / 71	42	D2PAK
	IRFZ44NS SMD	N	55	49	94	19	12 / 44	17.5	D2PAK
	IRFZ44ZS SMD	N	55	51	80	22	14 / 33	13.9	D2PAK
	IRL2910S SMD	N	100	55	200	28	11 / 49	26	D2PAK
	IRF3710S SMD	N	100	57	200	32	12 / 45	23	D2PAK
	IRF3710ZS SMD	N	100	59	160	35	17 / 41	18	D2PAK
	IRFZ48NS SMD	N	55	64	130	24	12 / 34	14	D2PAK
	IRL7833S SMD	N	30	75	140	150	18 / 21	4.5	D2PAK
	IRF4104S SMD	N	40	75	140	63	16 / 38	5.5	D2PAK
	IRF1010ZS SMD	N	55	75	140	33	18 / 36	7.5	D2PAK
	IRF1010NS SMD	N	55	75	180	32	13 / 39	11	D2PAK
	IRF1404S SMD	N	40	75	200	106	17 / 72	4	D2PAK
	IRL1404ZS SMD	N	40	75	230	120	200 / 80	3.1	D2PAK
	IRF2804S SMD	N	40	75	300	130	135 / 260	2	D2PAK
	IRF1018ES SMD	N	60	79	110	110	13 / 55	8.4	D2PAK
	IRL2505S SMD	N	55	104	200	59	12 / 43	8	D2PAK
	IRF3205S SMD	N	55	110	200	44	115 / 115	8	D2PAK
	IRL2203NS SMD	N	30	116	180	73	171 / 89	7	D2PAK
	IRF1404ZS SMD	N	40	120	200	170	18 / 36	3.7	D2PAK
	IRFS3306 SMD	N	60	120	230	230	15 / 40	4.2	D2PAK
	IRFS3206 SMD	N	60	120	300	210	19 / 55	3	D2PAK
	IRFS4310Z SMD	N	100	120	250	150	20 / 55	6	D2PAK
	IRL3803S SMD	N	30	140	200	55	14 / 29	6	D2PAK

1212-8

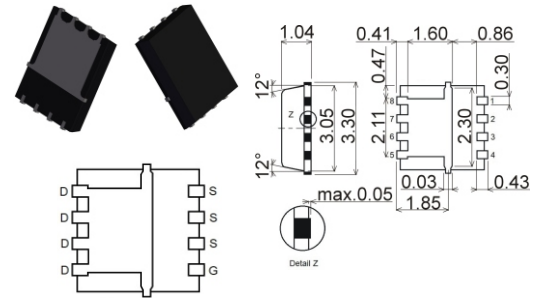

DirectFET

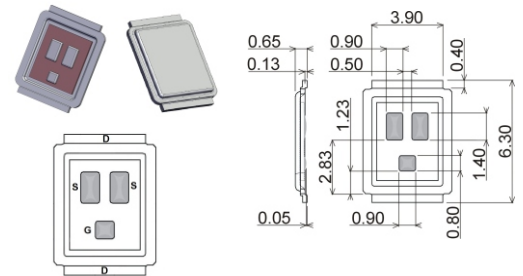

DPAK / TO252AA

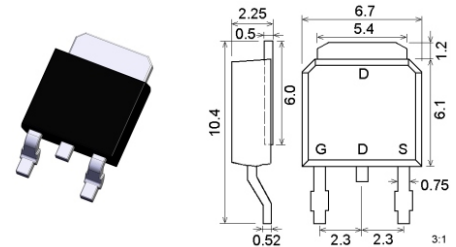

D2PAK / TO263AB

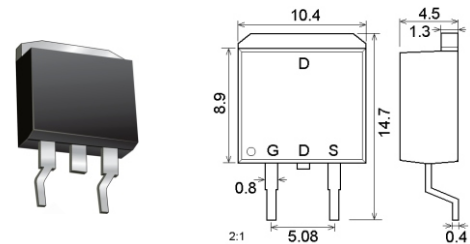



## Tranzistory MOSFET výkonové SMD kanál P

objednáací název	kanál	U <sub>ds</sub>	I <sub>d</sub>	P	g <sub>fs</sub>	ton/off	R <sub>dson</sub>	pouzdro
		V	A	W	S	ns	m	
SIS413DN-T1-GE3 SMD	P	30	18	52	50	55 / 40	9.4	1212-8
SI4835DDY SMD	P	30	13	5.6	23	11 / 32	30	SO8
IRFR9014 SMD	P	60	5.1	25	1.4	11 / 9.6	500	DPAK
IRFR9120N SMD	P	100	6.6	40	1.4	60 / 60	480	DPAK
IRFR9024 SMD	P	60	8.8	42	2.9	13 / 15	280	DPAK
IRFR9024N SMD	P	55	11	38	2.5	70 / 60	175	DPAK
IRFR5410 SMD	P	100	13	66	3.2	75 / 90	205	DPAK
IRFR5505 SMD	P	55	18	57	4.2	40 / 35	110	DPAK
IRFR5305 SMD	P	55	31	110	8	80 / 100	65	DPAK
IRF9224S SMD	P	60	11	60	1.4	80 / 45	280	D2PAK
IRF9530NS SMD	P	100	14	79	3.2	75 / 90	200	D2PAK
IRF9234S SMD	P	60	18	88	5.9	18 / 20	140	D2PAK
IRF9234NS SMD	P	55	19	68	4.2	13 / 30	100	D2PAK
IRF9540NS SMD	P	100	23	140	5.3	80 / 100	117	D2PAK
IRF5305S SMD	P	55	31	110	8	14 / 39	60	D2PAK
IRF5210S SMD	P	100	38	170	9.5	14 / 72	60	D2PAK
SUM110P04-05-E3 SMD	P	40	39	375	75	25 / 110	5	D2PAK
IRF4905S SMD	P	55	74	200	21	20 / 51	20	D2PAK

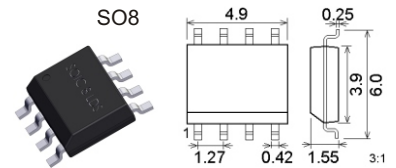
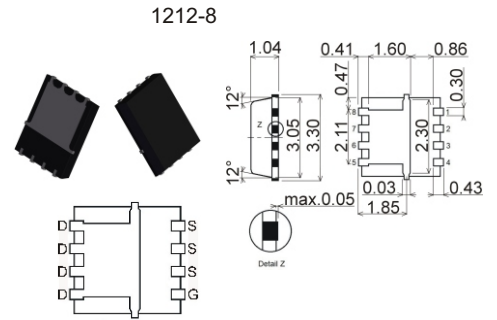

## Tranzistory MOSFET vysokonapět'ové SMD

objednáací název	kanál	U <sub>ds</sub>	I <sub>d</sub>	P	g <sub>fs</sub>	ton/off	R <sub>dson</sub>	pouzdro
		V	A	W	S	ns	m	
BSS131 SMD	N	240	0.1	0.36	0.13	3.3 / 13.7	20	SOT23 (3)
BSS139 SMD	N	250	0.1	0.36	0.13	5.8 / 29	30	SOT23 (3)
TN5325K1-G	N	250	0.15	0.36	0.15	20 / 25	7	SOT23 (3)
DN3135K1-G	N	350	0.07	0.36	0.14	10 / 15	35	SOT23 (3)
LND150K1-G	N	500	0.013	0.36	1000	90 / 100	1000	SOT23 (4)
BSP149 SMD	N	200	0.66	1.8	0.4	9 / 65	3.5	SOT223
IRFL210 SMD	N	200	0.96	2	0.51	8.2 / 14	1.5	SOT223
BSP129 SMD	N	240	0.2	1.8	0.36	4.4 / 22	20	SOT223
IRFL214 SMD	N	250	0.79	3.1	0.5	7 / 16	2	SOT223
BSP324 SMD	N	400	0.17	1.8	0.19	4.6 / 17	25	SOT223
TN2524N8-G	N	240	0.36	1.6*	0.6	10 / 20	6	SOT89
TN5325N8-G	N	250	0.32	1.6*	0.15	20 / 25	7	SOT89
DN3525N8-G	N	250	0.36	1.6*	0.225	20 / 25	6	SOT89
DN3535N8-G	N	350	0.23	1.6*	0.2	15 / 20	10	SOT89
TP2540N8-G	P	400	0.13	1.6*	0.175	10 / 20	30	SOT89
DN2540N8-G	N	400	0.17	1.6*	0.325	10 / 15	25	SOT89
DN3545N8-G	N	450	0.2	1.6*	0.15	20 / 30	20	SOT89
LND150N8-G	N	500	0.03	1.6	2	90 / 100	1	SOT89
VN2460N8-G	N	600	0.2	1.6*	0.05	10 / 25	20	SOT89
DN2470K4-G	N	700	0.17	2.5*	0.1	30 / 45	42	DPAK

\* montáž na DPS FR5 o rozměrech 25mm x 25mm x 1.57mm

## Tranzistory MOSFET vysokonapět'ové výkonové SMD

objednáací název	kanál	U <sub>ds</sub>	I <sub>d</sub>	P	g <sub>fs</sub>	ton/off	R <sub>dson</sub>	pouzdro
		V	A	W	S	ns	m	
IRFR9220 SMD	P	200	3.6	42	1.1	8.8 / 7.3	1500	DPAK
IRFR220N SMD	N	200	5	43	2.6	20 / 30	600	DPAK
IRFR310 SMD	N	400	1.7	25	0.9	18 / 32	3600	DPAK
IRFR9310 SMD	P	400	1.8	50	0.91	21 / 50	7000	DPAK
IRFR320 SMD	N	400	3.1	42	1.7	10 / 30	1800	DPAK
IRFR420 SMD	N	500	2.4	42	1.5	8 / 33	3000	DPAK
IRFRC20 SMD	N	600	2	42	1.4	33 / 55	4400	DPAK
IRF630NS SMD	N	200	9.3	82	4.9	7.9 / 27	300	D2PAK
IRF9640S SMD	P	200	11	125	4.1	14 / 39	500	D2PAK
IRL640S SMD	N	200	17	125	16	90 / 95	180	D2PAK
IRF640NS SMD	N	200	18	150	6.8	10 / 23	150	D2PAK
IRFS38N20D SMD	N	200	43	300	17	16 / 29	54	D2PAK
IRFS4227 SMD	N	200	62	330	49	33 / 21	22	D2PAK
IRF840S SMD	N	500	8	125	4.9	14 / 49	850	D2PAK

DPAK / TO252AA

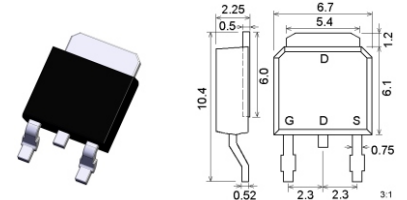

D2PAK / TO263AB

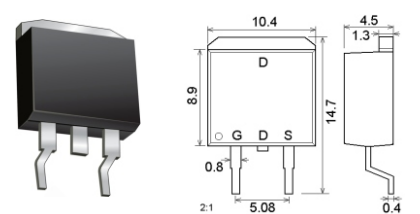

SOT23 / TO236AB

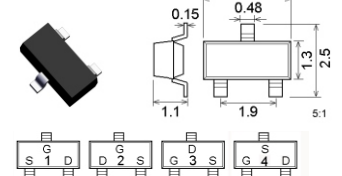

SOT89 / TO243AA

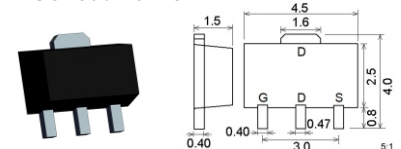

SOT223 / TO261AA

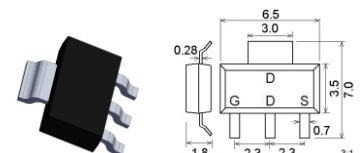

■ součástka se doplňuje na sklad | # součástka na skladě, výprodej | novinka = zelené podbarvení | Dodací podmínky neoznačených součástek sdělíme na poptávku



## Tranzistory MOSFET SMD s ochranou elektrody G (ESD)

objednávací název	kanál	U <sub>ds</sub>	I <sub>d</sub>	P	g <sub>fs</sub>	ton/off	R <sub>dson</sub>	pouzdro
		V	A	W	S	ns	m	
SIA459EDJ-T1-GE3 SMD	P	20	7.4	15.6	15	20 / 40	35	SC-70-6L
BSS138K SMD	N	50	0.2	0.225	0.1	5 / 5	10000	SOT23 (3)
TSM2N7002KCX SMD	N	60	0.3	0.3	0.1	25 / 35	4000	SOT23 (3)

## Dvojice tranzistorů MOSFET SMD

objednávací název	kanál	U <sub>ds</sub>	I <sub>d</sub>	P	g <sub>fs</sub>	ton/off	R <sub>dson</sub>	pouzdro
		V	A	W	S	ns	m	
DMN5L06DVK SMD	2x N	50	0.31	0.25	0.2	2.1 / 14.4	3000	SOT363
IRF7103 SMD	2x N	50	3	2	3.8	17 / 70	130	SO8
IRF8910 SMD	2x N	20	10	2	24	6.2 / 9.7	13.4	SO8
IRF7101 SMD	2x N	20	3.5	2	1.1	7 / 24	100	SO8
IRF7301 SMD	2x N	20	5.2	2	8.3	9.0 / 32	50	SO8
IRF7303 SMD	2x N	30	4.9	2	5.2	6.8 / 22	50	SO8
IRF7313 SMD	2x N	30	6.5	2	14	8.1 / 26	30	SO8
IRF7341 SMD	2x N	55	4.7	2	7.9	13 / 45	50	SO8
IRF7311 SMD	2x N	20	6.6	2	20	25 / 69	29	SO8
IRF7331 SMD	2x N	20	7	2	14	30 / 160	30	SO8
IRL6372 SMD	2x N	30	8.1	2	30	19 / 49	17.9	SO8
IRF8313 SMD	2x N	30	9.7	2	23	18 / 13	15.5	SO8
IRF7104 SMD	2x P	55	2.3	2	2.5	12 / 42	250	SO8
IRF7342 SMD	2x P	55	3.4	2	3.3	24 / 65	105	SO8
IRF7306 SMD	2x P	30	3.6	2	2.5	11 / 25	100	SO8
IRF7304 SMD	2x P	20	4.7	2	4	35 / 84	90	SO8
IRF7316 SMD	2x P	30	4.9	2	7.7	26 / 66	58	SO8
IRF7314 SMD	2x P	20	5.3	2	5.9	15 / 42	98	SO8
AO4821 SMD	2x P	12	9	2	45	820 / 11	19	SO8
IRF7324 SMD	2x P	20	9	2	19	17 / 170	18	SO8
AO8807L SMD	2x P	12	6.5	1.4	45	820 / 11	20	TSSOP8
IRF7309 SMD	N	30	4	1.4	5.2	6.8 / 22	80	SO8
	P	30	3		2.5	11 / 25	160	
IRF9952 SMD	N	30	3.5	2	12	6.2 / 13	150	SO8
	P	30	2.3		2.4	9.7 / 20	400	
IRF7105 SMD	N	25	3.5	2	4.3	7 / 45	160	SO8
	P	25	2.3		3.1	12 / 45	400	
IRF7343 SMD	N	55	4.7	2	7.9	12 / 45	50	SO8
	P	55	3.4		3.3	14 / 65	105	
IRF7307 SMD	N	20	5.2	2	8.3	51 / 83	50	SO8
	P	20	4.3		4	35 / 83	90	
IRF7319 SMD	N	30	6.5	2	14	17 / 43	29	SO8
	P	30	4.9		7.7	26 / 66	58	

SC-70-6L / PowerPAK

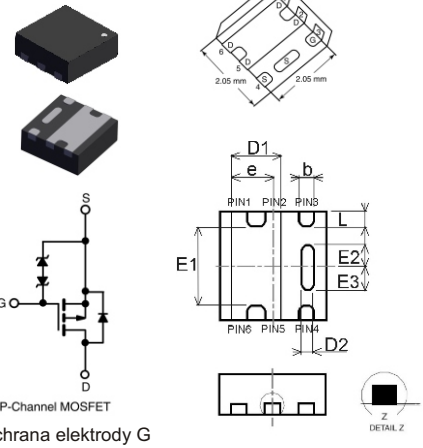

pouzdro	b	D1	D2	E1	E2	E3	K1	K2	L
	mm	mm	mm	mm	mm	mm	mm	mm	mm
PowerPAK	0.30	0.95	0.24	1.50	0.40	0.48	0.40	0.24	0.28

SOT23 / TO236AB

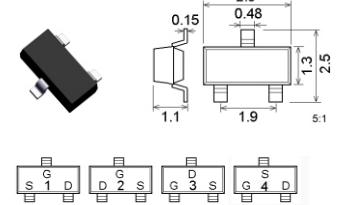

SOT363 / SC88 / SC70-6

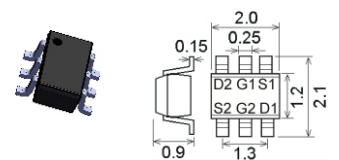

## Tranzistory Smart FET SMD

objednávací název	U <sub>ds</sub>	I <sub>d</sub>	P	E <sub>as</sub>	g <sub>fs</sub>	ton/off	R <sub>dson</sub>	pouzdro
	V	A	W	mJ	S	ns	m	
BSP76 SMD	42	1.4	3.8	150		45 / 600	240	SOT223
ITS711L1 SMD	43	1.9	3.6	150		0.2 / 0.2	200	DSO20
BTS721L1 SMD	42	2.9	3.7	300		0.2 / 0.2	100	DSO20
VNB10N07 SMD	70	10	50		8	50 / 230	100	D2PAK

SO8

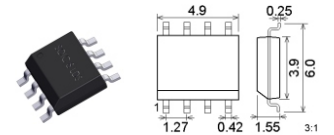

TSSOP8

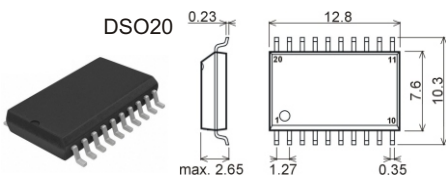
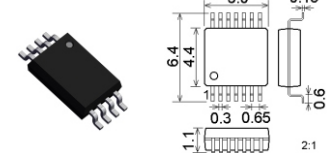

D2PAK / TO263AB

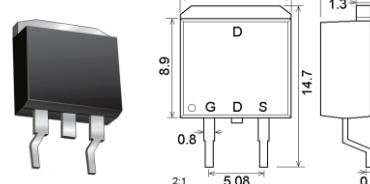

SOT223 / TO261AA

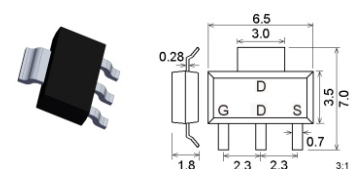

■ součástka se doplňuje na sklad | # součástka na skladě, výprodej | novinka = zelené podbarvení | Dodací podmínky neoznačených součástek sdělíme na poptávku

## Tranzistory J-FET

objednávací název	U <sub>dg</sub>	I <sub>d</sub>	P	g <sub>fs</sub>	R <sub>ds</sub>	pouzdro
kanál N	V	mA	W	mS		
■ J112	35	5	0.35		50	TO92 (5)
BF245A	30	2~6.5	0.35	3~6.5		TO92 (4)
■ BF256B	30	6~13	0.35	>4.5		TO92 (4)
BF245B	30	6~15	0.35	3~6.5		TO92 (4)
BF245C	30	12~25	0.35	3~6.5		TO92 (4)

TO92 / SC43 / SOT54

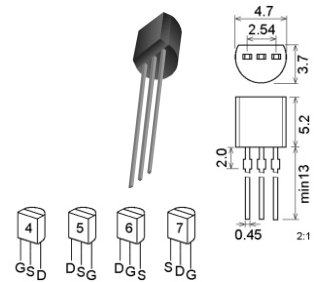

## Tranzistory J-FET SMD

objednávací název	U <sub>dg</sub>	I <sub>d</sub>	P	g <sub>fs</sub>	R <sub>ds</sub>	pouzdro	
kanál N	kanál P	V	mA	W	mS		
■ MMBFJ177LT1G SMD		25	1.5~20	0.225		300	SOT23
■ BFR31 SMD		30	1~5	0.25	1~4.5		SOT23
■ BF545A SMD		30	2~6.5	0.25	3~6.5		SOT23

## Tranzistory IGBT

objednávací název	U <sub>ce</sub>	I <sub>c</sub>	P	anti-paralelní vnitřní dioda	U <sub>ce(on)</sub>	@V <sub>ge</sub>	@I <sub>c</sub>	pouzdro
N kanál	V	A	W		V	V	A	
# IRG4BC20UD	600	13	60	ANO	1.85	15	6.5	TO220
■ IRG4BC20U	600	13	60	NE	1.85	15	6.5	TO220
■ IRG4BC20KD	600	16	60	ANO	2.27	15	9	TO220
■ IRG4BC20FD	600	16	60	ANO	1.66	15	9	TO220
■ IRG4BC20S	600	19	60	NE	1.4	15	10	TO220
■ IRG4BC30UD	600	23	100	ANO	1.95	15	12	TO220
■ IRG4BC30U	600	23	100	NE	1.95	15	12	TO220
■ IRG4BC30K	600	28	100	NE	2.21	15	16	TO220
■ IRG4BC40U	600	40	160	NE	1.72	15	20	TO220
■ IRGB30B60K	600	78	370	NE	1.95	15	30	TO220
■ STGB19NC60KD	600	16	32	ANO	4.5 / 6.5	4.5 / 6.5	0.00025	TO220IS
■ IRG4PH40UD	1200	41	160	ANO	2.43	15	21	TO247
■ IRG4PH40U	1200	41	160	NE	2.43	15	21	TO247
■ IRG4PC40FD	600	49	160	ANO	1.5	15	27	TO247
■ IRG4PF50W	900	51	200	NE	2.25	15	28	TO247
■ IRG4PC50W	600	55	200	NE	1.93	15	27	TO247

SOT23 / TO236AB

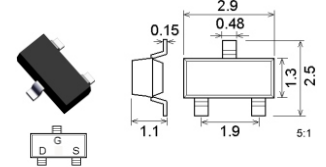

TO220

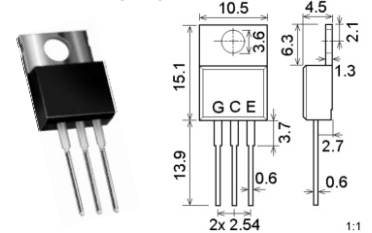

## Tranzistory IGBT SMD

objednávací název	U <sub>ce</sub>	I <sub>c</sub>	P	anti-paralelní vnitřní dioda	U <sub>ce(on)</sub>	@V <sub>ge</sub>	@I <sub>c</sub>	pouzdro
N kanál	V	A	W		V	V	A	
■ STGD14NC60KT4 SMD	600	25	80	NE	4.5 / 6.5	4.5 / 6.5	0.00025	DPAK

DPAK / TO252AA

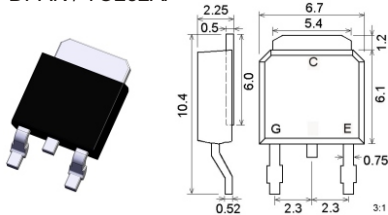

TO247

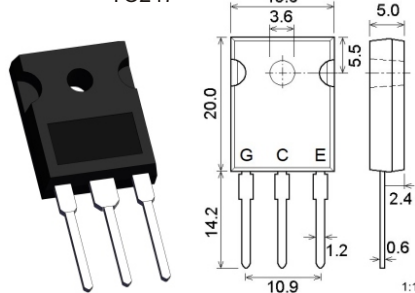

TO220IS

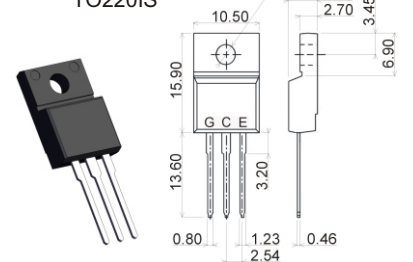

## IGBT Tranzistory - parametry

**U<sub>ce</sub> (V)** - nejvyšší dovolené napětí kolektor - emitor

**U<sub>ce(on)</sub> (V)** - úbytek napětí kolektor-emitor při definovaném V<sub>ge</sub> a I<sub>c</sub>

**U<sub>ge</sub> (V)** - hodnota napětí gate - emitor při kterém je změřeno U<sub>ce(on)</sub>

**I<sub>c</sub> (A)** - nejvyšší dovolený proud kolektoru

**@I<sub>c</sub> (A)** - hodnota proudu kolektoru při kterém je změřeno U<sub>ce(on)</sub>

**P (W)** - nejvyšší dovolená výkonová ztráta

■ součástka se doplňuje na sklad | # součástka na skladě, výprodej | novinka = **zelené podbarvení** | Dodací podmínky neoznačených součástek sdělíme na poptávku