

Diody spínací do 1A

obj. název	UR	IF @ TA		IFSM	IR	tr	UFM @ IF		pouzdro
	V	mA	°C	mA	A	ns	V	mA	
■ 1N4148 T/B	75	150	25	500	5.0	4	1.00	10	DO35
■ 1N4448 T/B	100	150	25	500	5.0	4	1.00	100	DO35
■ BAV 21 T/B	200	200	25	1000	0.1	50	1.00	100	DO35

Diody pro všeobecné použití 1A

obj. název	UR	IF @ TA		IFSM	IR	UFM @ IF		pouzdro
	V	A	°C	A	A	V	A	
■ 1N4007 T/B	1000	1	75	30	5	1.10	1.0	DO41
■ BY133 T/B	1300	1	75	30	5	1.10	1.0	DO41
■ EM516 T/B	1800	1	75	30	5	1.10	1.0	DO41
■ EM520 T/B	2000	1	75	30	5	1.10	1.0	DO41

Diody pro všeobecné použití 2A až 10A

obj. název	UR	IF @ TA		IFSM	IR	UFM @ IF		pouzdro
	V	A	°C	A	A	V	A	
■ RL207 T/B	1000	2	75	70	5	1.10	2.0	DO15
■ 1N5408 T/B	1000	3	105	200	10	1.20	2.0	DO27
■ BY255 T/B	1300	3	105	200	5	1.10	3.0	DO27
■ P600M T/B	1000	6	60	400	5	1.00	6.0	R6
■ LT10A07 T/B	1000	10	50	600	10	1.00	10.0	R6

Diody rychlé 1A

obj. název	UR	IF @ TA		IFSM	IR	tr	UFM @ IF		pouzdro
	V	A	°C	A	A	ns	V	A	
■ BYV26C	600	1	75	30	5	30	1.30	1.0	SOD57
■ SF18 T/B	600	1	55	30	5	35	1.70	1.0	DO41
■ UF4007 T/B	1000	1	55	30	5	75	1.70	1.0	DO41
■ BA159 T/B	1000	1	75	30	5	500	1.30	1.0	DO41

Diody rychlé 2A až 6A

obj. název	UR	IF @ TA		IFSM	IR	tr	UFM @ IF		pouzdro
	V	A	°C	A	A	ns	V	A	
■ SF24 T/B	200	2	55	75	5	35	0.95	2.0	DO15
■ SF26 T/B	400	2	55	75	5	35	1.25	2.0	DO15
# SF28 T/B	600	2	55	75	5	35	1.70	2.0	DO15
# FR205 T/B	600	2	75	70	5	250	1.30	2.0	DO15
■ BY299 T/B	800	2	75	70	5	500	1.30	2.0	DO15
■ FR207 T/B	1000	2	75	70	5	500	1.30	2.0	DO15
■ SF36 T/B	400	3	55	125	5	35	1.25	3.0	DO27
■ SF56 T/B	400	5	55	150	5	35	1.25	5.0	DO27
■ SF38 T/B	600	3	55	125	5	35	1.70	3.0	DO27
■ SF58 T/B	600	5	55	150	5	35	1.70	5.0	DO27
■ BY399 T/B	800	3	75	200	10	500	1.30	3.0	DO27
■ FR307 T/B	1000	3	75	200	10	500	1.30	3.0	DO27
■ UF5408 T/B	1000	3	55	150	10	75	1.70	3.0	DO27
■ FR607 T/B	1000	6	75	300	10	500	1.30	6.0	R6

Diody rychlé 8A až 15A

obj. název	UR	IF @ TA		IFSM	IR	tr	UFM @ IF		pouzdro
	V	A	°C	A	A	ns	V	A	
■ SF84 T/B	200	8	100	125	10	35	1.00	8.0	TO220AC
■ BYV79E /200	200	14	120	160	10	30	0.90	14.0	TO220AC
# SF86 T/B	400	8	100	125	10	50	1.35	8.0	TO220AC
■ SF88 T/B	600	8	100	125	10	50	1.70	8.0	TO220AC
■ STPR860D	600	8	100	90	10	50	1.50	8.0	TO220AC
■ MUR1560	600	15	145	150	10	60	1.20	15.0	TO220AC

Diody rychlé 2x5A až 2x15A

obj. název	UR	IF @ TA		IFSM	IR	tr	UFM @ IF		pouzdro
	V	A	°C	A	A	ns	V	A	
■ BYV32E -200	200	2x10	115	137	10	25	0.72	8.0	TO220AB
# SF166	400	2x8	125	150	10	50	1.35	8.0	TO220AB
■ STPR1060CT	600	2x5	125	55	10	50	1.70	5.0	TO220AB
■ SF168	600	2x8	125	150	10	50	1.70	8.0	TO220AB
■ SF304	200	2x15	100	300	10	35	1.00	15.0	TO3P
■ SF306	400	2x15	100	300	10	50	1.35	15.0	TO3P
■ SF308	600	2x15	100	300	10	50	1.70	15.0	TO3P

DO35

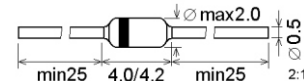

SOD57

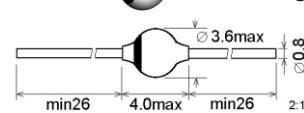

DO41



DO15



DO27 (DO201AD)



R6

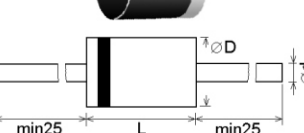

	D mm	L mm	d mm
DO 41	2.0 ~ 2.7	4.2 ~ 5.2	0.7 ~ 0.9
DO 15	2.6 ~ 3.6	5.8 ~ 7.6	0.7 ~ 0.9
DO 27 (DO 201AD)	5.0 ~ 5.6	8.5 ~ 9.5	1.2 ~ 1.3
R6	8.6 ~ 9.1	8.6 ~ 9.1	1.2 ~ 1.3

TO220AC TO220AB

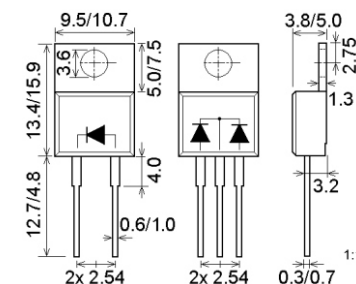
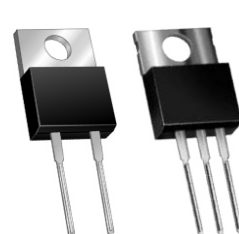

TO3P

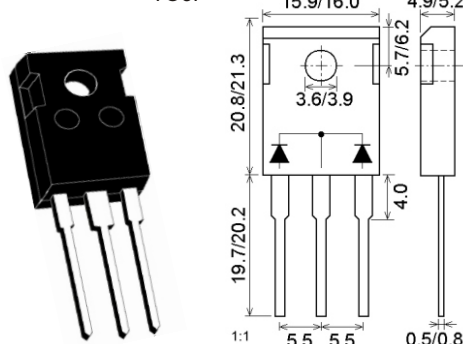

■ součástka se doplňuje na sklad | # součástka na skladě, výprodej | novinka = **zelené podbarvení** | Dodací podmínky neoznačených součástek sdělíme na poptávku

Diodový blok až 100A, diody až 2x50A

obj. název	UR	IF @ TA		IFSM	IR	UFM @ IF		pouzdro
	V	A	°C	A	mA	V	A	
MD100C16D1	1600	2x50	109	2500	5	1.20	300.0	D1

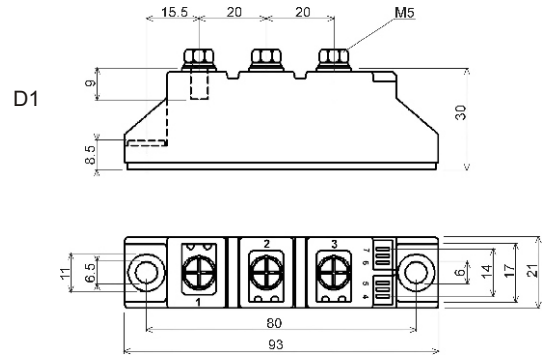

DIODY SMD

Diody spínací SMD do 0.5A

obj. název	UR	IF @ TA		IFSM	IR	tr	UFM @ IF		pouzdro
	V	mA	°C	A	nA	ns	V	mA	
LS4148WT SMD T/R	100	150	25	0.8	5000	4	1.00	10	0603
LS4148WS SMD T/R	100	150	25	0.8	5000	4	1.00	10	0805
LS4448WS SMD T/R	100	250	25	0.8	5000	4	1.00	100	0805
LS4148W SMD T/R	100	150	25	0.8	5000	4	1.00	10	1206
LS4448W SMD T/R	100	250	25	0.8	5000	4	1.00	100	1206
1N4148WTF SMD T/R	75	150	25	0.3	5000	4	1.00	10	SOD523F
BAS16F SMD T/R	75	200	25	0.5	1000	4	0.86	10	SOD523F
BAS16X SMD T/R	75	200	25	0.5	1000	6	0.86	10	SOD523
1N4148WSF SMD T/R	75	150	25	0.3	5000	4	1.00	10	SOD323F
BAS16-03W SMD	80	250	25	4.5	1000	4	1.20	100	SOD323
1N4148WS SMD T/R	100	150	25	2.0	2500	4	1.00	50	SOD323
BAV19WS SMD T/R	100	200	25	0.5	100	50	1.00	100	SOD323
BAV16WS SMD T/R	100	250	25	2.0	1000	6	0.86	10	SOD323
BAV21WS SMD T/R	200	200	25	0.5	100	50	1.00	100	SOD323
BAV21WSF SMD T/R	250	200	25	1.0	100	50	1.00	100	SOD323F
1N4151W T/R	50	150	25	0.5	50	4	1.00	50	SOD123
1N4148W T/R	75	150	25	2.0	2500	4	1.00	50	SOD123
1N4448W T/R	75	150	25	4.0	2500	4	1.00	100	SOD123
BAV99 SMD T/R	75	150	25	2.0	2500	6	1.00	10	SOT23 (4)
BAV70 SMD T/R	75	150	25	2.0	2500	6	1.00	10	SOT23 (3)
BAW56 SMD T/R	75	150	25	2.0	2500	6	1.00	10	SOT23 (2)
BAV199 SMD T/R	75	200	25	2.0	5	3	1.00	10	SOT23 (4)
BAS16 SMD T/R	75	250	25	2.0	1000	6	0.86	10	SOT23 (1)
BAS19 SMD T/R	100	200	25	2.5	100	50	1.00	100	SOT23 (1)
BAS21LT1 SMD T/R	250	200	25	2.5	1000	50	1.00	100	SOT23 (1)
BAV99W SMD T/R	75	150	25	2.0	2500	6	1.00	10	SOT323 (4)
BAS16W SMD T/R	100	150	25	2.0	1000	6	0.86	10	SOT323 (1)
DLM4148 SMD T/R	75	150	25	0.5	5000	4	1.00	10	MicroMELF
DLQ4148 SMD T/R	75	150	25	0.5	5000	4	1.00	10	QuadroMELF
LL4448 SMD T/R	75	150	25	0.5	5000	4	1.00	100	MiniMELF
LL4148 SMD T/R	75	150	25	0.5	5000	4	1.00	10	MiniMELF
BAV103 SMD T/R	250	200	25	1.0	100	50	1.00	100	MiniMELF

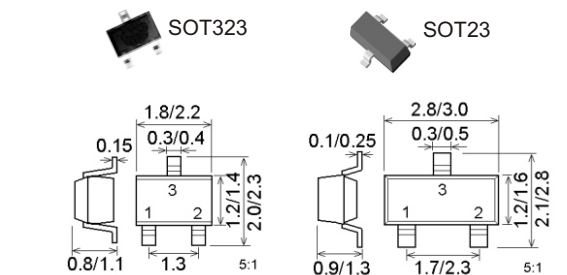
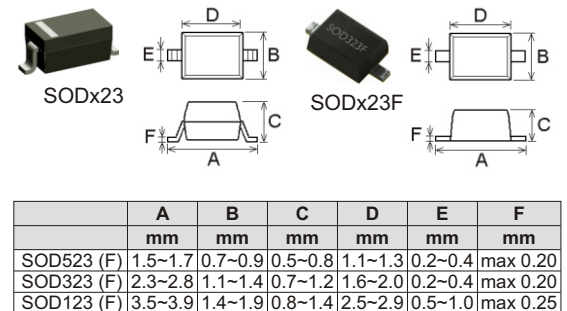
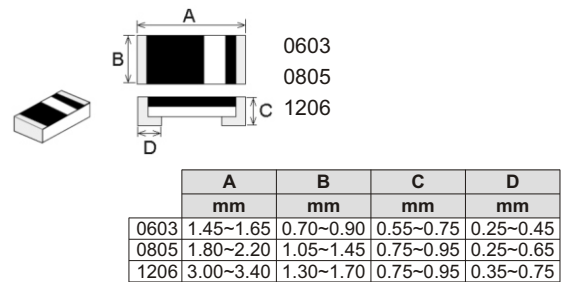

Diody pro všeobecné použití SMD 0.5A až 1A

obj. název	UR	IF @ TA		IFSM	IR	UFM @ IF		pouzdro
	V	A	°C	A	A	V	A	
S1MFL SMD T/R	1000	1.0	25	25	5	1.10	1.0	SOD123F
GL34M T/R	1000	0.5	55	10	5	1.10	0.5	MiniMELF
SM4007S SMD T/R	1000	1.0	75	30	5	1.10	1.0	MiniMELF
SM4007 SMD T/R	1000	1.0	75	30	5	1.10	1.0	MELF
S1M SMA T/R	1000	1.0	25	30	5	1.10	1.0	SMA
M7 SMD T/R	1000	1.0	75	30	5	1.10	1.0	SMA
GS1M SMD T/R	1000	1.0	75	30	5	1.10	1.0	SMA
S1M SMB T/R	1000	1.0	75	30	5	1.10	1.0	SMB

1) polovodičový přechod pasivován sklem

MELF (DO213AB, LL41, SM1)

QuadroMELF

MiniMELF (SOD80, DO213AA, LL34, SM2)

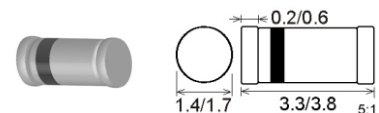
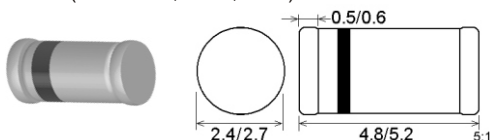

■ součástka se doplňuje na sklad | # součástka na skladě, výprodej | novinka = zelené podbarvení | Dodací podmínky neoznačených součástek sdělíme na poptávku

Diody pro všeobecné použití SMD 1.5A až 5A

obj. název	UR	IF @ TA		IFSM	IR	UFM @ IF		pouzdro
	V	A	°C			A	A	
■ SM5399 SMD T/R	1000	1.5	75	50	5	1.40	1.5	MELF
S2MA SMD T/R	1000	1.5	100	50	5	1.15	1.5	SMA
■ S2M SMD T/R	1000	2.0	75	60	5	1.10	2.0	SMB
S3MB SMD T/R	1000	3.0	75	100	10	1.15	3.0	SMB
■ S3M SMD T/R	1000	3.0	100	100	10	1.15	3.0	SMC
S5MC SMD T/R	1000	5.0	75	100	10	1.15	5.0	SMC

Diody rychlé SMD 0.5A až 1A

obj. název	UR	IF @ TA		IFSM	IR	tr	UFM @ IF		pouzdro
	V	A	°C				A	A	
■ SF1JFL SMD T/R	600	1.0	25	25	5	35	1.70	1.0	SOD123F
■ RGL34G SMD T/R	400	0.5	55	10	5	150	1.30	0.5	MiniMELF
■ RGL34M SMD T/R	1000	0.5	55	10	5	500	1.30	0.5	MiniMELF
FSM104 SMD T/R	400	1.0	55	30	5	150	1.30	1.0	MELF
ESM108 SMD T/R	600	1.0	55	30	5	35	1.70	1.0	MELF
HSM108 SMD T/R	1000	1.0	55	30	5	75	1.70	1.0	MELF
FSM107 SMD T/R	1000	1.0	55	30	5	500	1.30	1.0	MELF
■ ES1D SMD T/R	200	1.0	55	30	5	35	0.95	1.0	SMA
■ RS1G SMD T/R	400	1.0	90	30	5	150	1.30	1.0	SMA
■ ES1J SMD T/R	600	1.0	55	30	5	35	1.70	1.0	SMA
# US1K SMD T/R	800	1.0	50	30	5	100	1.70	1.0	SMA
■ US1M SMD T/R	1000	1.0	75	30	5	75	1.70	1.0	SMA
■ RS1M SMD T/R	1000	1.0	90	30	5	500	1.30	1.0	SMA

Diody rychlé SMD 2A až 20A

obj. název	UR	IF @ TA		IFSM	IR	tr	UFM @ IF		pouzdro
	V	A	°C				A	A	
ES2JA SMD T/R	600	2	110	50	5	35	1.30	2.0	SMA
ES3DB SMD T/R	200	3	110	100	10	25	0.92	3.0	SMB
ES3GB SMD T/R	400	3	110	100	10	25	1.25	3.0	SMB
ES3JB SMD T/R	600	3	110	100	10	35	1.30	3.0	SMB
■ ER2J SMD T/R	600	2	75	60	5	35	1.70	2.0	SMB
■ UF2K SMD T/R	800	2	75	60	10	100	1.70	2.0	SMB
RS3MB SMD T/R	1000	3	75	100	5	500	1.30	3.0	SMB
■ ER3J SMD T/R	600	3	75	100	5	35	1.70	3.0	SMC
# UF3K SMD T/R	800	3	75	100	10	100	1.70	3.0	SMC
# US3M SMD T/R	1000	3	100	100	10	75	1.30	3.0	SMC
■ HS3M SMD T/R	1000	3	25	100	10	75	1.70	3.0	SMC
■ MUR520D	200	5	100	60	5	25	0.97	5.0	DPAK
■ STTH1002CB	200	2x8	135	50	5	25	1.10	5.0	DPAK
■ STTH4R02B	200	4	160	70	3	30	1.05	4.0	DPAK
■ SFS1602G SMD	100	2x8	25	125	10	35	0.97	8.0	D2PAK
MURB1620 CT	200	2x8	125	100	5	25	0.97	8.0	D2PAK
■ BYV32EB/200	200	2x10	115	137	6	25	0.85	8.0	D2PAK
■ SFS1604G SMD	200	2x8	25	125	10	35	0.97	8.0	D2PAK
■ SFS1608G SMD	600	2x8	25	125	10	35	0.97	8.0	D2PAK
■ UGS5J SMD	600	5	25	65	20	20	2.00	5.0	D2PAK

SMA (DO214AC)

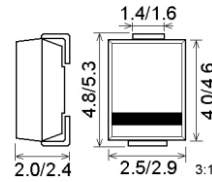

SMB (DO214AA)

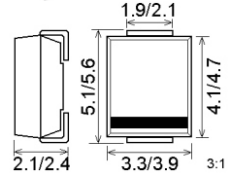

SMC (DO214AB)

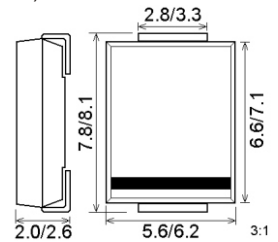

DPAK (TO252AA)

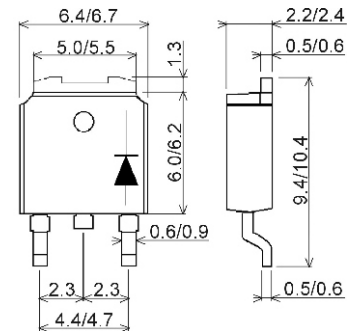

D2PAK (TO263)

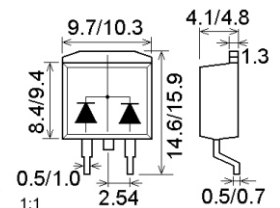
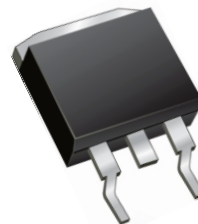

DIODY SCHOTTKY

Diody Schottky 0.15A až 2A

obj. název	UR	IF @ TA		IFSM	IR	UFM @ IF		pouzdro
	V	mA	°C			A	A	
■ BAT42 T/B	30	200	75	4.00	0.5	0.40	10	DO 35
■ BAT43 T/B	30	200	75	4.00	0.5	0.33	2	DO 35
■ BAT85 T/B	30	200	75	4.00	2.0	0.80	100	DO 35
■ SD103A T/B	40	350	25	2.00	5.0	0.60	200	DO 35
■ BAT46 T/B	100	150	25	0.75	5.0	0.45	10	DO 35
■ 1N5819 T/B	40	1000	90	25.00	1.0	0.60	1000	DO 41
■ SR160 T/B	60	1000	55	40.00	1.0	0.70	1000	DO 41
■ SR260 T/B	60	2000	135	100.00	2.0	0.70	2000	DO 41
■ SR180 T/B	80	1000	55	40.00	1.0	0.75	1000	DO 41
# SR1100 T/B	100	1000	55	40.00	1.0	0.85	1000	DO 41



DO35

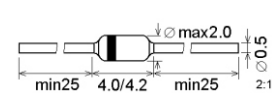

DO41

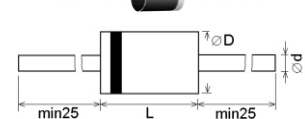

	D	L	d
	mm	mm	mm
DO 35	1.5 ~ 2.3	3.1 ~ 5.1	0.4 ~ 0.6
DO 41	2.0 ~ 2.7	4.2 ~ 5.2	0.7 ~ 0.9
DO 27 (DO 201AD)	5.0 ~ 5.6	8.5 ~ 9.5	1.2 ~ 1.3

■ součástka se doplňuje na sklad | # součástka na skladě, výprodej | novinka = **zelené podbarvení** | Dodací podmínky neoznačených součástek sdělíme na poptávku

Diody Schottky 3A až 16A

obj. název	UR		IF @ TA		IFSM	IR	UFM @ IF		pouzdro
	V	A	°C	A			V	A	
SR540 T/B	40	5	60	150	5.0	5.0	0.55	5.0	DO 27
SB840 T/B	40	8	90	175	1.0	0.55	8.0	8.0	DO 27
SQ1045 T/B	45	10	25	275	0.5	0.55	10.0	10.0	DO 27
1N5822 T/B	40	3	95	80	2.0	0.52	3.0	3.0	DO 27
SR360 T/B	60	3	95	80	3.0	0.75	3.0	3.0	DO 27
SR560 T/B	60	5	60	150	5.0	0.70	5.0	5.0	DO 27
SR3100 T/B	100	3	95	80	3.0	0.85	3.0	3.0	DO 27
SR5100 T/B	100	5	60	150	5.0	0.85	5.0	5.0	DO 27
SB5150 T/B	150	5	150	125	0.8	0.92	5.0	5.0	DO 27
SR840	40	8	100	150	5.0	0.65	8.0	8.0	TO 220AC
MBR745	45	7	125	150	0.1	0.84	15.0	15.0	TO 220AC
MBR1645	45	16	110	200	0.2	0.63	16.0	16.0	TO 220AC
SR860	60	8	100	150	5.0	0.75	8.0	8.0	TO 220AC
SRA1060	60	10	110	250	1.0	0.70	10.0	10.0	TO 220AC
MBR1660	60	16	100	200	0.2	0.75	16.0	16.0	TO 220AC
MBR1060	60	10	25	100	0.2	0.75	5.0	5.0	TO 220AC
SR880	80	8	100	150	5.0	0.85	8.0	8.0	TO 220AC
SR8100	100	8	100	150	5.0	0.85	8.0	8.0	TO 220AC
15SQ045	45	15	25	320	0.5	0.50	15.0	15.0	R-6

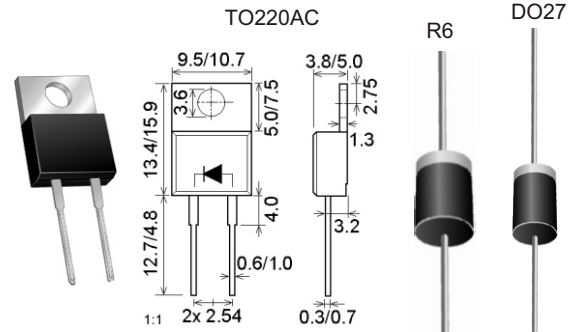

Diody Schottky 2x5A až 2x30A

obj. název	UR		IF @ TA		IFSM	IR	UFM @ IF		pouzdro
	V	A	°C	A			V	A	
MBR3030CT	30	2x15	100	200	0.2	0.70	15.0	15.0	TO 220AB
SR1640	40	2x8	115	150	5.0	0.65	8.0	8.0	TO 220AB
MBR3045CT	45	2x15	100	200	0.2	0.70	15.0	15.0	TO 220AB
SR1060	60	2x5	105	150	5.0	0.75	5.0	5.0	TO 220AB
SR1660	60	2x8	115	150	5.0	0.75	8.0	8.0	TO 220AB
SR2060	60	2x10	90	150	5.0	0.75	10.0	10.0	TO 220AB
MBR3060CT	60	2x15	100	200	0.2	0.80	15.0	15.0	TO 220AB
SR10100	100	2x5	105	150	5.0	0.85	5.0	5.0	TO 220AB
SR16100	100	2x8	115	150	5.0	0.85	8.0	8.0	TO 220AB
SR20100	100	2x10	90	150	5.0	0.85	10.0	10.0	TO 220AB
MBR30100CT	100	2x15	125	200	0.1	0.80	15.0	15.0	TO 220AB
MBR10150CT	150	2x5	105	120	0.8	0.92	5.0	5.0	TO 220AB
MBR20150CT	150	2x10	120	180	0.8	0.92	10.0	10.0	TO 220AB
MBR10200CT	200	2x5	105	120	0.8	0.92	5.0	5.0	TO 220AB
MBR20200CT	200	2x10	120	180	0.8	0.92	10.0	10.0	TO 220AB
MBR6045PT	45	2x30	125	450	1.0	0.62	30.0	30.0	TO 3P
SR3060	60	2x15	90	300	5.0	0.75	15.0	15.0	TO 3P
MBR6060PT	60	2x30	125	450	1.0	0.72	30.0	30.0	TO 3P

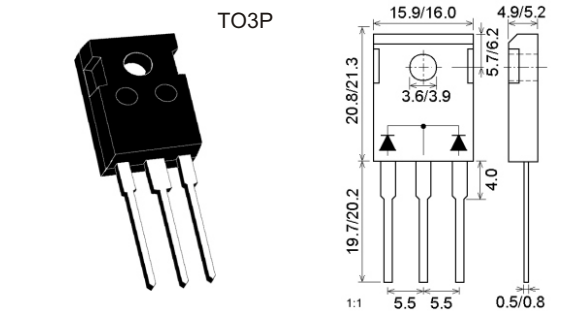
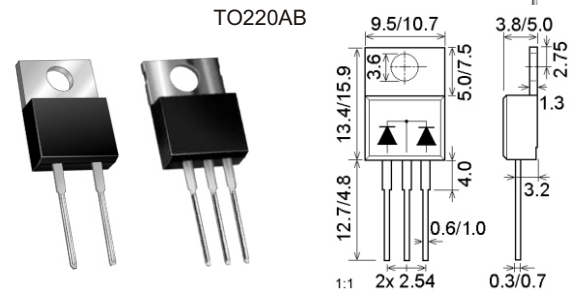

DIODY SCHOTTKY SMD

Diody Schottky SMD do 0.5A

obj. název	UR		IF @ TA		IFSM	IR	UFM @ IF		pouzdro
	V	mA	°C	A			V	mA	
BAT54X SMD T/R	30	100	25	0.60	2.0	1.00	100	100	SOD523
RB520S-30 SMD T/R	30	200	25	1.00	1.0	0.60	200	200	SOD523
BAT42WS SMD T/R	30	200	25	4.00	0.5	0.40	10	10	SOD323
BAT43WS SMD T/R	30	200	75	4.00	0.5	0.65	50	50	SOD323
BAT54WS SMD T/R	30	200	75	0.60	2.0	1.00	100	100	SOD323
SD103AWS SMD T/R	40	350	25	2.00	5.0	0.60	200	200	SOD323
SD103AWS-F SMD T/R	40	350	25	2.00	5.0	0.60	200	200	SOD323F
BAT43W SMD T/R	30	200	75	4.00	0.5	0.65	50	50	SOD123
BAT42W SMD T/R	30	200	25	4.00	0.5	0.40	10	10	SOD123
SD103AW SMD T/R	40	350	25	2.00	5.0	0.60	200	200	SOD123
SS0540 SMD T/R	40	500	25	5.50	20.0	0.51	500	500	SOD123
DLM103A SMD T/R	40	350	25	2.00	5.0	0.60	200	200	MicroMELF
BAS386 SMD	50	200	25	5.00	5.0	0.45	10	10	MicroMELF
BAS85 SMD T/R	30	200	75	0.60	2.0	0.80	100	100	MiniMELF
LL42 SMD T/R	30	200	75	4.00	0.5	0.65	50	50	1) MiniMELF
LL43 SMD T/R	30	200	75	4.00	0.5	0.65	50	50	2) MiniMELF
BAS81 SMD	40	30	25	0.50	0.2	1.00	15	15	MiniMELF
LL103A SMD T/R	40	200	25	15.00	5.0	0.60	200	200	MiniMELF
BAT48 SMD	40	350	25	1.50	25.0	0.75	200	200	MiniMELF
BAT46 SMD	100	150	25	0.35	5.0	0.45	10	10	MiniMELF
DLQ103A SMD T/R	40	350	25	2.00	5.0	0.60	200	200	QuadroMELF
BAT54A SMD T/R	30	200	75	0.60	2.0	1.00	100	100	SOT23 (2)
BAT54C SMD T/R	30	200	75	0.60	2.0	1.00	100	100	SOT23 (3)
BAT54S SMD T/R	30	200	75	0.60	2.0	1.00	100	100	SOT23 (4)
BAS40-04 SMD T/R	40	200	25	0.60	0.2	1.00	40	40	SOT23 (4)
BAS40 SMD T/R	40	200	25	0.60	0.2	1.00	40	40	SOT23 (1)
BAT54AW SMD T/R	30	200	75	0.60	2.0	1.00	100	100	SOT323 (2)
BAT54CW SMD T/R	30	200	75	0.60	2.0	1.00	100	100	SOT323 (3)
BAT54SW SMD T/R	30	200	75	0.60	2.0	1.00	100	100	SOT323 (4)
BAT46W SMD T/R	100	150	25	10.00	5.0	0.45	10	10	SOT323 (1)
BAT46WFILM SMD T/R	100	150	25	10.00	2.0	0.45	10	10	SOT323 (1)

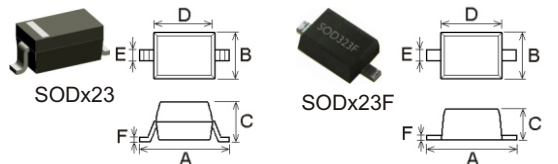

	A	B	C	D	E	F
	mm	mm	mm	mm	mm	mm
SOD523 (F)	1.5~1.7	0.7~0.9	0.5~0.8	1.1~1.3	0.2~0.4	max 0.20
SOD323 (F)	2.3~2.8	1.1~1.4	0.7~1.2	1.6~2.0	0.2~0.4	max 0.20
SOD123 (F)	3.5~3.9	1.4~1.9	0.8~1.4	2.5~2.9	0.5~1.0	max 0.25

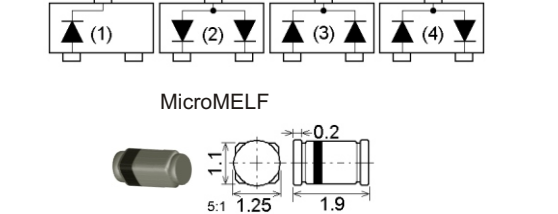
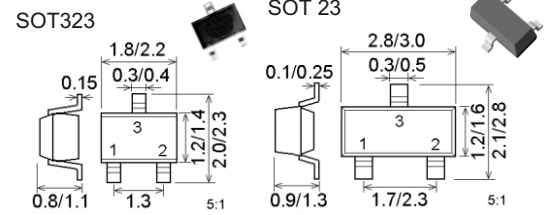

1) LL42: Ufm=0.4V @ If=0.01A 2) LL43: Ufm=0.33V @ I=0.002A

■ součástka se doplňuje na sklad | # součástka na skladě, výprodej | novinka = zelené podbarvení | Dodací podmínky neoznačených součástek sdělíme na poptávku

Diody Schottky SMD 1A

obj. název	UR	IF @ TA		IFSM	IR	UFM @ IF		pouzdro
	V	A	°C			A	mA	
■ B5819WS SMD T/R	40	1	25	9	1.00	0.60	1.0	SOD323
■ PMEG4010BEA	40	1	55	10	0.10	0.64	1.0	SOD323
■ 1N5819W SMD T/R	40	1	55	30	1.00	0.60	1.0	SOD123
■ SK16FL SMD T/R	60	1	25	25	1.00	0.70	1.0	SOD123F
■ SM5819 SMD T/R	40	1	90	25	1.00	0.60	1.0	MELF
■ SM160 SMD T/R	60	1	100	40	1.00	0.70	1.0	MELF
■ SS16 SMD T/R	60	1	55	30	1.00	0.70	1.0	SMA
■ SS16A SMD T/R	60	1	25	30	10.00	0.70	1.0	SMA
■ SS110 SMD T/R	100	1	55	30	1.00	0.85	1.0	SMA
■ SK14 SMD T/R	40	1	100	50	1.00	0.55	1.0	SMB
■ SK16 SMD T/R	60	1	75	50	1.00	0.70	1.0	SMB
■ SK110 SMD T/R	100	1	75	50	1.00	0.85	1.0	SMB
■ DFSL1100-7 SMD	100	1	25	50	0.35	0.77	1.0	PowerDI123

Diody Schottky SMD 2A

obj. název	UR	IF @ TA		IFSM	IR	UFM @ IF		pouzdro
	V	A	°C			A	mA	
■ SK26FL SMD T/R	60	2	25	40	1.0	0.70	2.0	SOD123F
■ SM260 SMD T/R	60	2	90	40	2.0	0.75	2.0	MELF
■ SS24 SMD	40	2	75	50	2.0	0.55	2.0	SMA
■ SS24A SMD T/R	40	2	25	50	0.5	0.70	2.0	SMA
■ B2150A SMD T/R	150	2	75	50	0.2	0.82	2.0	SMA
■ SK24 SMD T/R	40	2	75	50	2.0	0.55	2.0	SMB
■ SK26 SMD T/R	60	2	100	50	2.0	0.70	2.0	SMB
■ SK28 SMD T/R	80	2	100	50	2.0	0.85	2.0	SMB
■ SK210 SMD T/R	100	2	100	50	2.0	0.85	2.0	SMB

Diody Schottky SMD 3A až 5A

obj. název	UR	IF @ TA		IFSM	IR	UFM @ IF		pouzdro
	V	A	°C			A	mA	
■ B340A SMD T/R	40	3	100	100	0.5	0.50	3.0	SMA
■ B360A SMD T/R	60	3	100	100	0.5	0.70	3.0	SMA
■ B360B SMD T/R	60	3	100	100	0.5	0.70	3.0	SMB
■ SK34 SMD T/R	40	3	75	100	2.0	0.55	3.0	SMC
■ B340 SMD T/R	40	3	100	100	0.5	0.50	3.0	SMC
■ B540C SMD T/R	40	5	90	175	0.5	0.55	5.0	SMC
■ SK36 SMD T/R	60	3	100	100	2.0	0.75	3.0	SMC
■ B360 SMD T/R	60	3	100	100	0.5	0.70	3.0	SMC
■ B560C SMD T/R	60	5	90	175	0.5	0.70	5.0	SMC
■ SK38 SMD T/R	80	3	100	100	2.0	0.85	3.0	SMC
■ SK310 SMD T/R	100	3	100	100	2.0	0.85	3.0	SMC
■ B3100 SMD T/R	100	3	100	100	0.5	0.79	3.0	SMC

Diody Schottky SMD 2x0.2A

obj. název	UR	IF @ TA		IFSM	IR	UFM @ IF		pouzdro
	V	A	°C			A	V	
# BAT54V SMD	30	2x0.2	25	0.6	2	1.00	0.1 *	SOT563

* montáž na PCB FR4 o rozměrech 1"x0.85"x0.062"

Diody Schottky SMD 2x8A

obj. název	UR	IF @ TA		IFSM	IR	UFM @ IF		pouzdro
	V	A	°C			A	mA	
■ SD1640D SMD	40	2x8.0	90	150.0	5	0.65	8.0	D2PAK
■ SD16100D SMD	100	2x8.0	90	150.0	5	0.85	8.0	D2PAK

QuadroMELF

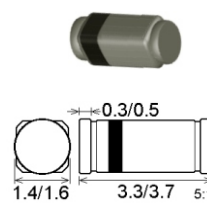

MiniMELF (SOD80, DO213AA, LL34, SM2)

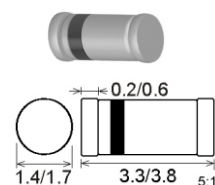

MELF (DO213AB, LL41, SM1)

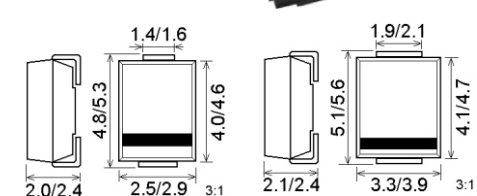
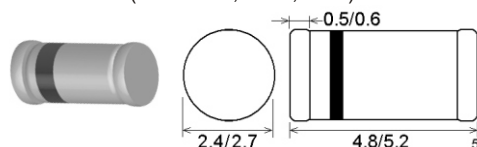

SMC (DO214AB)

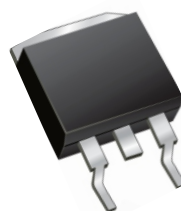
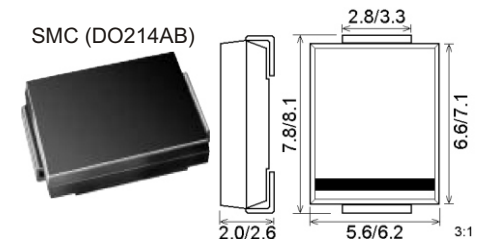

D2PAK (TO263)

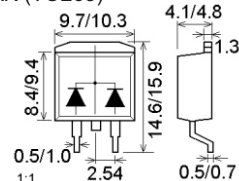

PowerDI123

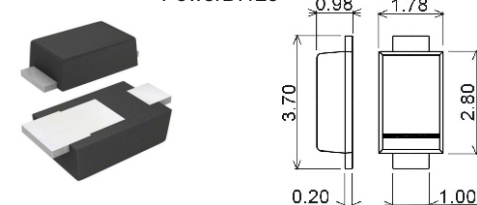

SOT563

